



**SUPPLEMENTO  
CATALOGO  
GENERALE**

---

**2026**

MINUTERIE IDRAULICHE  
RUBINETTERIA

**art. 1250T**

Colonna doccia  
con supporto regolabile.

cod. art.	mis.	€	conf.
1250T.000		112,000	1

Asta: acciaio inox  
Scorrevole: ABS  
Supporto: ABS  
Deviatore: ottone  
Soffione anticalcare:  $\varnothing$  200 mm ABS  
Doccia anticalcare: ABS  
Tubo doccia spiralato: cm 150  
Tubo deviatore spiralato: cm 60  
Pressione min. di esercizio: 0,5 Bar  
Pressione max. di esercizio: 5 Bar  
Temperatura min. di esercizio: 5°C  
Temperatura max. di esercizio: 70°C  
Collegamento idraulico: 1/2" F.  
Finitura: **cromata**

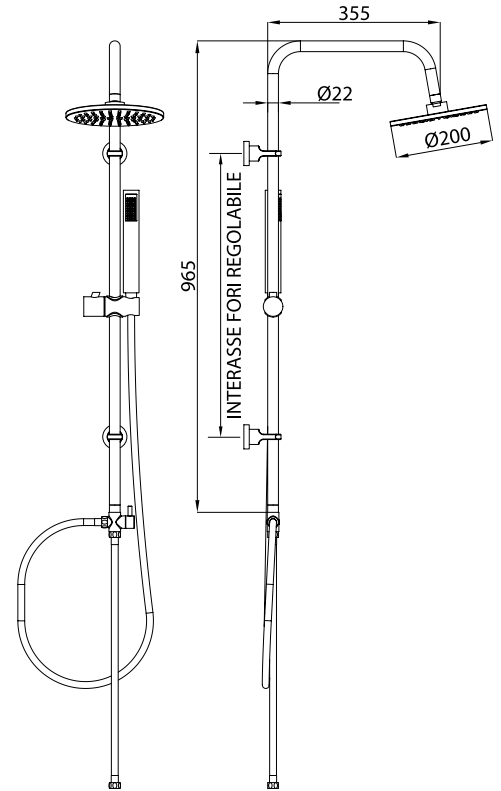

**SUPPORTO  
REGOLABILE**



**DEVIATORE  
IN OTTONE**

art. **1250Q**

Colonna doccia  
con supporto regolabile.

cod. art.	mis.	€	conf.
1250Q.000		119,000	1

Asta: acciaio inox  
 Scorrevole: ABS  
 Supporto: ABS  
 Deviatore: ottone  
 Soffione anticalcare: 200x200 mm ABS  
 Doccia anticalcare: ABS  
 Tubo doccia spiralato: cm 150  
 Tubo deviatore spiralato: cm 60  
 Pressione min. di esercizio: 0,5 Bar  
 Pressione max. di esercizio: 5 Bar  
 Temperatura min. di esercizio: 5°C  
 Temperatura max. di esercizio: 70°C  
 Collegamento idraulico: 1/2" F.  
 Finitura: **cromata**

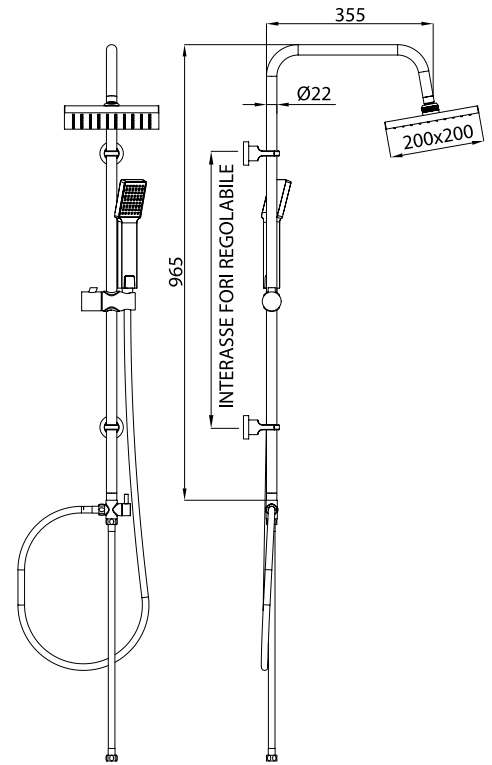

**SUPPORTO  
REGOLABILE**



**DEVIATORE  
IN OTTONE**

**art. 1250N**

Colonna doccia  
con supporto regolabile.

cod. art.	mis.	€	conf.
1250N.000		140,000	1

Asta: acciaio inox  
Scorrevole: ABS  
Supporto: ABS  
Deviatore: ottone  
Soffione anticalcare:  $\varnothing$  200 mm ABS  
Doccia anticalcare: ABS  
Tubo doccia PVC: cm 150  
Tubo deviatore PVC: cm 60  
Pressione min. di esercizio: 0,5 Bar  
Pressione max. di esercizio: 5 Bar  
Temperatura min. di esercizio: 5°C  
Temperatura max. di esercizio: 70°C  
Collegamento idraulico: 1/2" F.  
Finitura: **nera opaca**

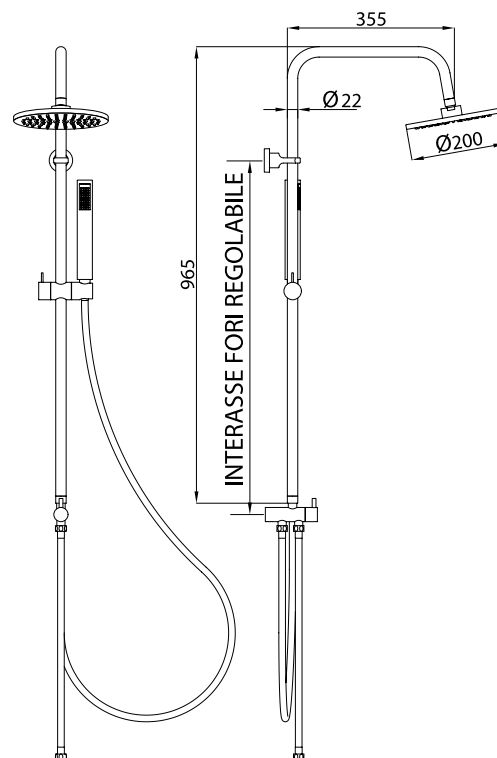

**SUPPORTO  
REGOLABILE**



**DEVIATORE  
IN OTTONE**

art. **1251T**

Colonna doccia  
con supporto regolabile  
e deviatore a pulsante  
con mensola.

Asta: acciaio inox  
Scorrevole: ABS  
Supporto: ABS  
Deviatore a pulsante  
con mensola: ABS  
Soffione anticalcare:  $\varnothing$  200 mm ABS  
Doccia anticalcare: ABS  
Tubo doccia spiralato: cm 150  
Tubo deviatore spiralato: cm 60  
Pressione min. Di esercizio: 0,5 Bar  
Pressione max. Di esercizio: 5 Bar  
Temperatura min. Di esercizio: 5°C  
Temperatura max. Di esercizio: 70°C  
Collegamento idraulico: 1/2" F.  
Finitura: **cromata**

cod. art.	mis.	€	conf.
1251T.000		145,000	1

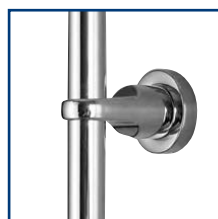
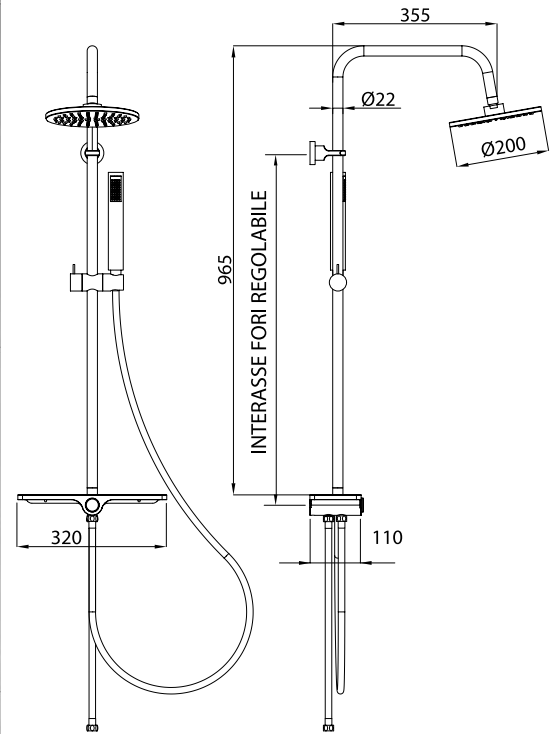

**SUPPORTO  
REGOLABILE**



**DEVIATORE  
A PULSANTE  
CON MENSOLA**

**art. 1252Q**

Colonna doccia  
con supporto regolabile.

cod. art.	mis.	€	conf.
1252Q.000		180,000	1

Asta: acciaio inox  
Scorrevole: ABS  
Supporto: ABS  
Deviatore: ottone  
Soffione anticalcare: 200x200 mm ABS  
Doccia anticalcare: ABS  
Tubo doccia spiralato: cm 150  
Tubo deviatore spiralato: cm 60  
Pressione min. Di esercizio: 0,5 Bar  
Pressione max. Di esercizio: 5 Bar  
Temperatura min. Di esercizio: 5°C  
Temperatura max. Di esercizio: 70°C  
Collegamento idraulico: 1/2" F.  
Finitura: **cromata**

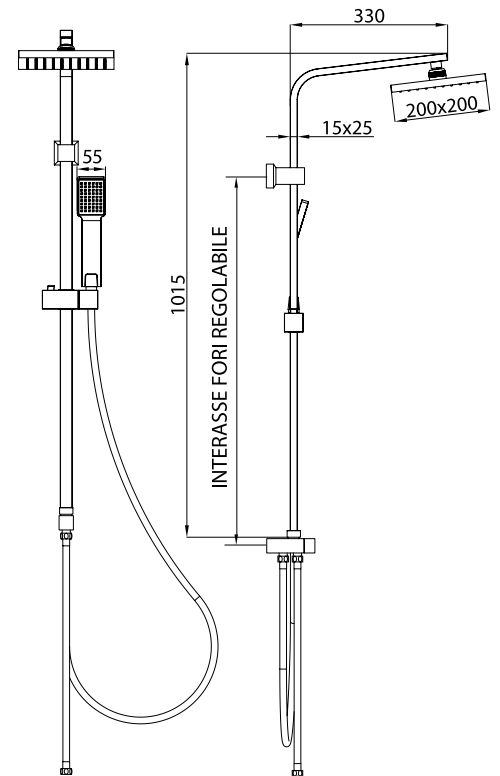

**SUPPORTO  
REGOLABILE**



**DEVIATORE  
IN OTTONE**

art. **1252N**

Colonna doccia  
con supporto regolabile.

cod. art.	mis.	€	conf.
1252N.000		187,000	1

Asta: acciaio inox  
Scorrevole: ABS  
Supporto: ABS  
Deviatore: ottone  
Soffione anticalcare: 200x200 mm ABS  
Doccia anticalcare: ABS  
Tubo doccia pvc: cm 150  
Tubo deviatore pvc: cm 60  
Pressione min. Di esercizio: 0,5 Bar  
Pressione max. Di esercizio: 5 Bar  
Temperatura min. Di esercizio: 5°C  
Temperatura max. Di esercizio: 70°C  
Collegamento idraulico: 1/2" F.  
Finitura: **nera opaca**

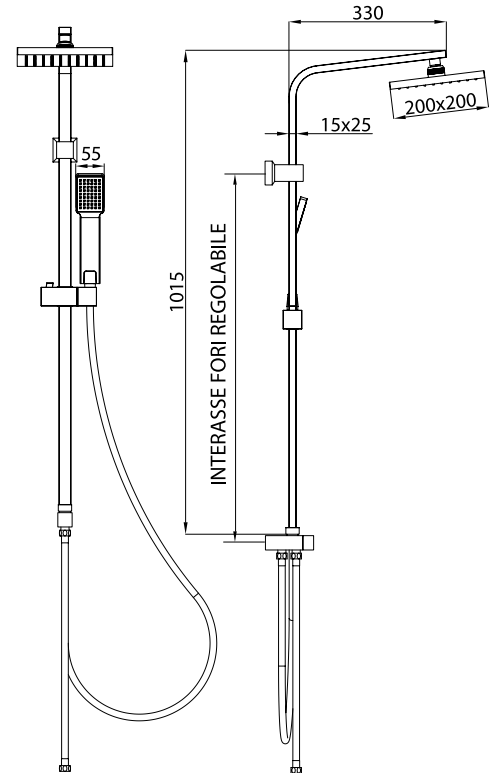

**SUPPORTO  
REGOLABILE**



**DEVIATORE  
IN OTTONE**

**art. 1254M**

Colonna doccia  
con supporto regolabile  
e miscelatore meccanico.

cod. art.	mis.	€	conf.
1254M.000		150,000	1

Miscelatore meccanico: ottone  
Asta: acciaio inox  
Scorrevole: ABS  
Supporto regolabile: metallo  
Deviatore: ottone  
Soffione anticalcare ø225mm: ABS  
Doccia 3 getti anticalcare ø110mm: ABS  
Tubo doccia spiralato: cm 150  
Pressione max. Di esercizio: 0,5 Bar  
Pressione min. Di esercizio: 5 Bar  
Temperatura min. Di esercizio: 5°C  
Temperatura max. Di esercizio: 70°C  
Collegamento idraulico: 1/2" M.  
Finitura: **cromata**

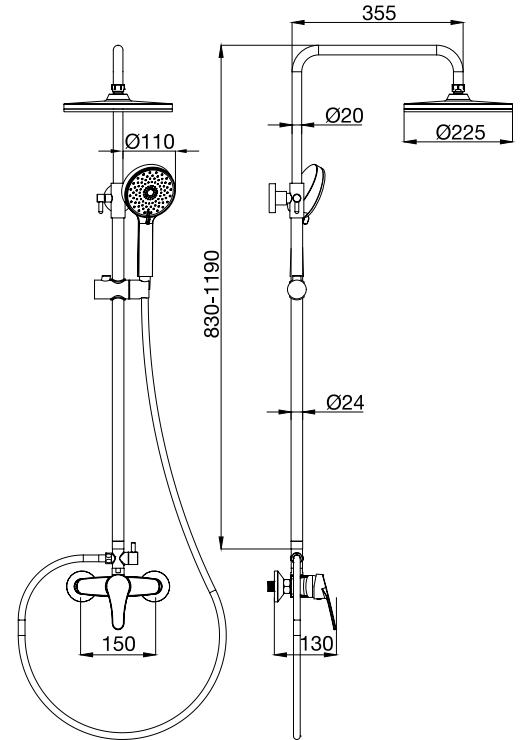

**SUPPORTO  
REGOLABILE**

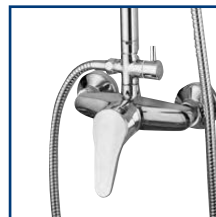

**DEVIATORE  
IN OTTONE**

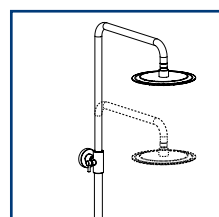

**ALTEZZA SOFFIONE  
REGOLABILE**

art. **1253N**

Colonna doccia  
con supporto regolabile  
e miscelatore meccanico.

cod. art.	mis.	€	conf.
1253N.000		160,000	1

Miscelatore meccanico: ottone  
Asta: acciaio inox  
Scorrevole: ABS  
Supporto regolabile: metallo  
Deviatore: ottone  
Soffione anticalcare  $\varnothing 225\text{mm}$ : ABS  
Doccia 3 getti anticalcare  $\varnothing 110\text{mm}$ : ABS  
Tubo doccia spiralato: cm 150  
Pressione min. Di esercizio: 0,5 Bar  
Pressione max. Di esercizio: 5 Bar  
Temperatura min. Di esercizio: 5°C  
Temperatura max. Di esercizio: 70°C  
Collegamento idraulico: 1/2" M.  
Finitura: **cromata**

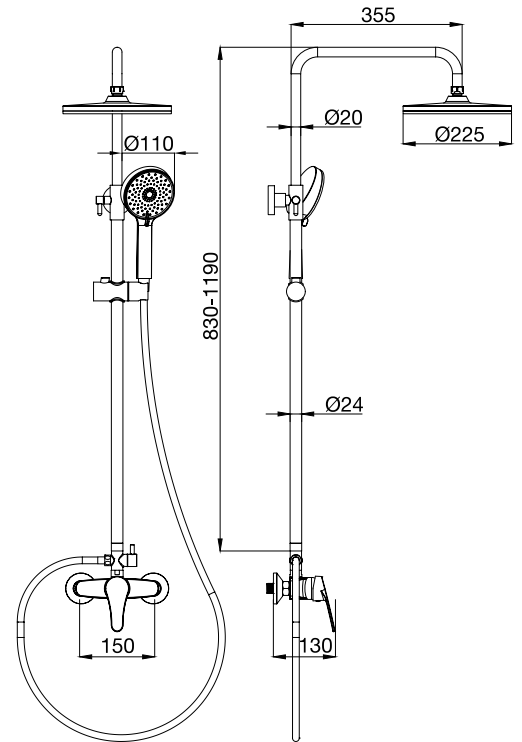

**SUPPORTO  
REGOLABILE**



**DEVIATORE  
IN OTTONE**

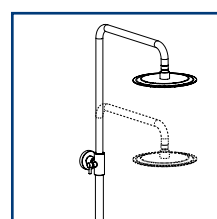

**ALTEZZA SOFFIONE  
REGOLABILE**

**art. 1820**

Saliscendi cromato con doccia  
5 funzioni anticalcare  
+ portasapone.

Mod. Baltimora



cod. art.	mis.	€	conf.
01820.080		88,000	2

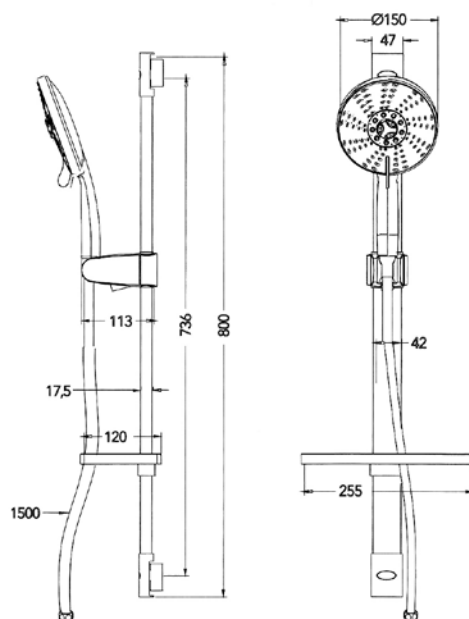

**art. 1821**

Saliscendi cromato con supporto regolabile  
e doccia 3 funzioni anticalcare  
+ portasapone.

Mod. Nevis

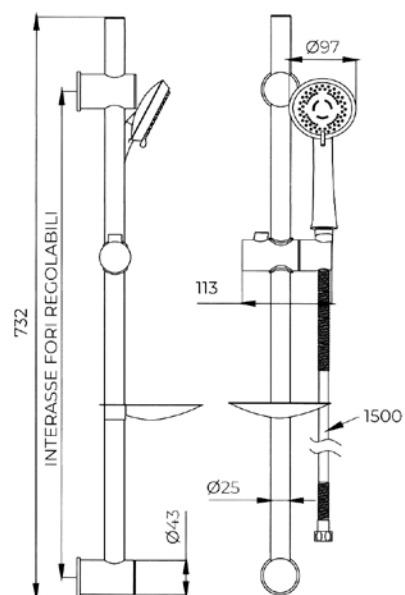

01821.070		54,000	2
-----------	--	--------	---



**art. 1821A**

Saliscendi cromato con supporto regolabile e doccia 3 getti anticalcare.

Mod. Rio

**art. 1821N**

Saliscendi nero opaco con supporto regolabile e doccia 3 funzioni anticalcar

Mod. Rio



cod. art.	mis.	€	conf.
<b>1821A.000</b>		<b>60,000</b>	<b>2</b>
<b>1821N.000</b>		<b>67,000</b>	<b>2</b>

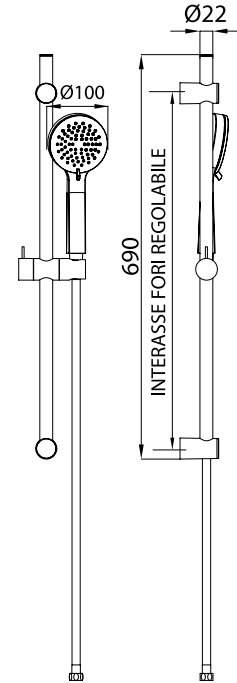

**art. 1298A**

Scorrevole a pulsante per saliscendi doccia con foro per asta Ø 22mm per nostro articolo 1250T e 1250Q. Materiale: ABS cromato



<b>1298A.000</b>		<b>10,500</b>	<b>5</b>
------------------	--	---------------	----------

**art. 1298B**

Scorrevole con levetta per saliscendi doccia con foro per asta Ø 22mm per nostro articolo 1821A 1821N 1251T e 1250N. Materiale: ABS cromato e nero opaco



<b>1298B.CRO</b>	cromato	<b>12,500</b>	<b>5</b>
<b>1298B.NER</b>	nero opaco	<b>14,600</b>	<b>5</b>

### art. 1824

Saliscendi cromato con doccia  
3 funzioni anticalcare.  
Fissaggio adesivo

Mod. Quick

cod. art.	mis.	€	conf.
01824.070		105,000	2

### art. 1824N

Saliscendi nero opaco con doccia  
3 funzioni anticalcare.  
Fissaggio adesivo

Mod. Quick

1824N.070		112,000	2
-----------	--	---------	---

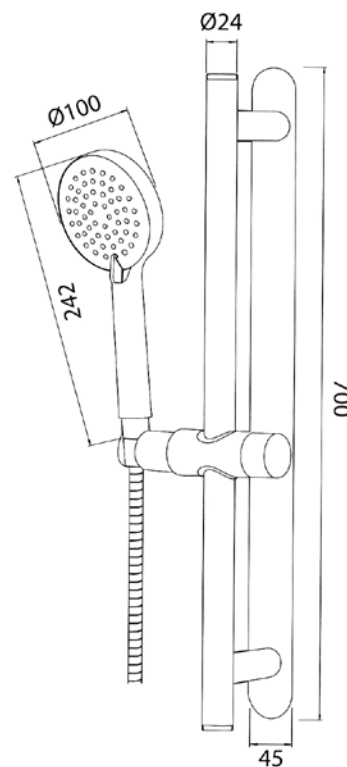

Asta: Acciaio Inox

Scorrevole: ABS

Adesivo: **3M**

Doccia 3 getti anticalcare: Ø100 mm ABS

Pressione min. di esercizio: 0,5 bar

Pressione max. di esercizio: 5 bar

Temperatura min. di esercizio: 5°C

Temperatura max di esercizio: 70°C

Collegamento idraulico: 1/2"F

Finitura: **cromata** o **nera opaca**.

#### ISTRUZIONI DI MONTAGGIO



Pulire e sgrassare la superficie di supporto.  
Accertarsi prima di procedere che la superficie sia asciutta e liscia.

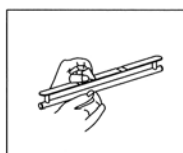

Rimuovere la pellicola protettiva dall'adesivo.



Applicare alla parete e tenere premuto 30 secondi per avere un'ottima aderenza.

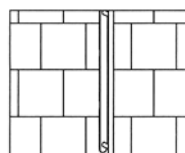

Attendere 24 ore prima di caricare il prodotto



**SISTEMA DI FISSAGGIO ADESIVO  
CON ADESIVO 3M  
PRATICO SEMPLICE E SICURO!**

### art. 6786

Kit braccio doccia  
con deviatore.

Bbraccio: acciaio inox  
Deviatore: ABS  
Supporto: ABS  
Soffione anticalcare: Ø225 mm ABS  
Doccia: ABS  
Tubo doccia spiralato: cm 150  
Pressione min. Di esercizio: 1 Bar  
Pressione max. Di esercizio: 5 Bar  
Temperatura min. Di esercizio: 5°C  
Temperatura max. Di esercizio: 70°C  
Collegamento idraulico: 1/2" M.  
Finitura: **cromata**

cod. art.	mis.	€	conf.
06786.000		256,000	2



**SOFFIONE  
ANTICALCARE**

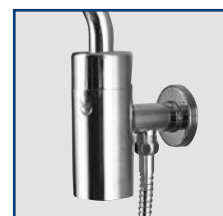

**DEVIATORE**

### art. 6725T

Kit doccia tondo.

Il Kit comprende:

Preso acqua tonda in ottone  
Doccia tonda in ottone  
Tubo doccia in PVC cm 150  
Soffione tondo inox Ø 25 cm  
Braccio doccia tondo  
con rosone da cm 35

6725T.KIT	205,000	1
-----------	---------	---



**art. 6726Q**

Kit doccia quadro.

Il Kit comprende:

Presa acqua quadra in ottone  
 Doccia quadra in ottone  
 Tubo doccia in PVC cm 150  
 Soffione quadro inox 25x25 cm  
 Braccio doccia quadro  
 con rosone da cm 35



cod. art.	mis.	€	conf.
<b>6726Q.KIT</b>		<b>255,000</b>	<b>1</b>

**art. 6785**

Kit doccetta tonda Shut-off salvaspazio con supporto e chiusura.

Il Kit comprende:

Doccetta tonda in ottone cromato  
 con pulsante a rilascio  
 Presa acqua tonda salvaspazio  
 con supporto e chiusura in ottone cromato  
 Tubo doccia Silver tondo da cm 120.



<b>06785.KIT</b>		<b>100,000</b>	<b>1</b>
------------------	--	----------------	----------

**art. 6785Q**

Kit doccetta quadra Shut-off salvaspazio con supporto e chiusura.

Il Kit comprende:

Doccetta quadrata in ottone cromato  
 con pulsante a rilascio  
 Presa acqua quadrata salvaspazio  
 con supporto e chiusura in ottone cromato  
 Tubo doccia Silver quadrato da cm 120.



<b>6726Q.KIT</b>		<b>127,500</b>	<b>1</b>
------------------	--	----------------	----------

**art. 6784R**

Presa acqua tonda salvaspazio con supporto e chiusura in ottone cromata.



<b>6784R.RUB</b>		<b>32,000</b>	<b>2</b>
------------------	--	---------------	----------

**art. 6794N**

Presa acqua tonda salvaspazio con supporto e chiusura in ottone  
Finitura: **nera opaca**



cod. art.	mis.	€	conf.
6794N.000		46,000	2

**art. 6787N**

Deviatore per colonna doccia maschio 3/4x1/2.  
Materiale: ottone  
Finitura: **nera opaca**



6794N.000		27,500	2
-----------	--	--------	---

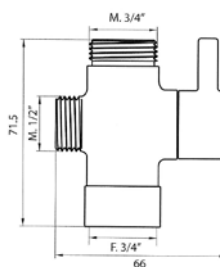

**art. 6788N**

Deviatore per colonna doccia maschio 1/2.  
Materiale: ottone  
Finitura: **nera opaca**



6794N.000		27,500	2
-----------	--	--------	---

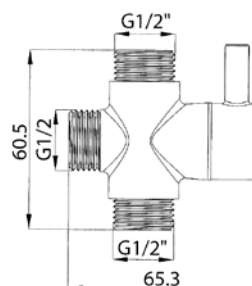

**art. 6778**

Doccia in ottone cromata tonda 3 funzioni.

Idroscopino  
Sht-off  
Stop



06778.000		35,000	1
-----------	--	--------	---

**art. 6778N**

Doccia in ottone nera opaca tonda 3 funzioni.

Idroscopino  
Sht-off  
Stop

06778.000		41,700	1
-----------	--	--------	---

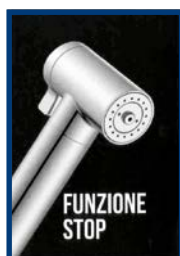

**art. 1825**

Doccetta 3 getti anticalcare  
in ABS cromata.

Mod. Rio

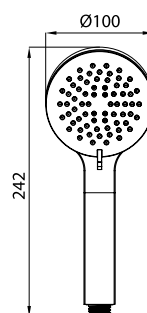

cod. art.	mis.	€	conf.
01825.CRO	Ø100	<b>17,000</b>	1
1825N.000	Ø100	<b>19,000</b>	1

**art. 1825N**

Doccetta 3 getti anticalcare  
in ABS nera opaca.

Mod. Rio

**art. 1287**

Doccetta monogetto anticalcare  
in ABS cromata.

Mod. Talento



01287.000	Ø100	<b>12,500</b>	1
-----------	------	---------------	---



**art. 1289N**

Doccetta 4 getti anticalcare  
in ABS nera opaca.

Mod. Vulcano

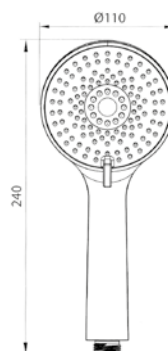

1289N.000	Ø110	<b>18,500</b>	1
-----------	------	---------------	---



**art. 1282A**

Doccetta 5 getti anticalcare  
in ABS cromata.

Mod. Onda

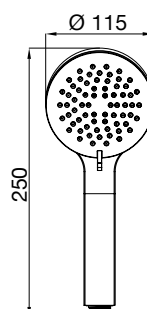

1282A.000	Ø115	<b>18,000</b>	1
-----------	------	---------------	---



**Sostituiscono**

**16 Art. 1272 - 1273 - 1281CRO - 1284CRO - 1831**

**art. 1823A**

Doccetta 3 getti anticalcare in ABS cromata.

Mod. Mon Chéri



cod. art.	mis.	€	conf.
1823A.000	Ø127	20,500	1

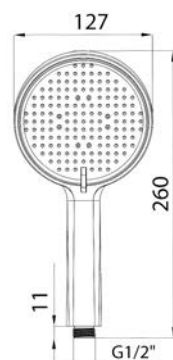

**art. 3924N**

Doccetta tonda in ABS  
Finitura: **nera opaca**.

Mod. Globo

**art. 3925N**

Doccetta quadra in ABS  
Finitura: **nera opaca**.

Mod. Tetris



3924N.000		12,500	1
3925N.000		17,300	1

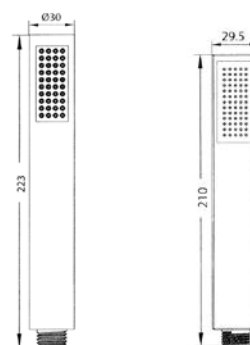

**art. 970**

Braccio doccia con rosone  
Acciaio Inox.  
Finitura: **cromata**.

Rosone L 138 mm H 131 mm



00970.000	cm 35	96,200	1
-----------	-------	--------	---

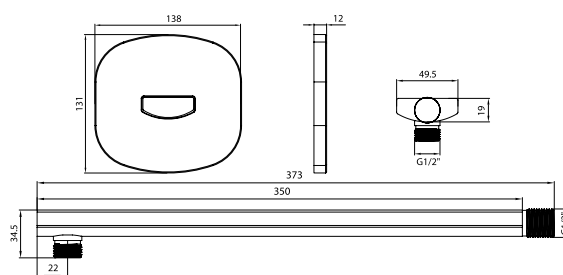

**art. 970N**

Braccio doccia con rosone  
Acciaio Inox.  
Finitura: **nera opaca**.

Rosone L 138 mm H 131 mm



0970N.000	cm 35	105,000	1
-----------	-------	---------	---

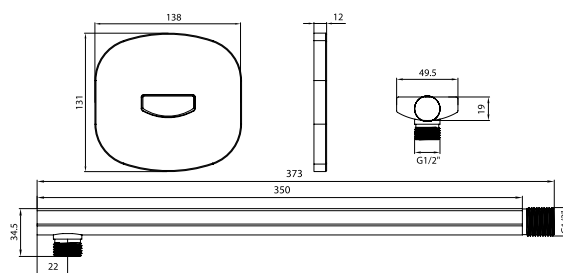

**art. 562**

Braccio doccia in ottone  
cromato inclinato Ø 21  
con rosone.



00562.160	mm 160	13,000	1
-----------	--------	--------	---

**art. 4400**

Miscelatore vasca esterno completo di doccia duplex. Serie Le Mans.

Cartuccia Ø40 mm.



cod. art.	mis.	€	conf.
04400.000		134,000	1

**art. 4402**

Miscelatore lavabo completo di scarico Norton in metallo da 1"1/4. Serie Le Mans.

Cartuccia Ø40 mm.



04402.000		98,500	1
-----------	--	--------	---

**art. 4404**

Miscelatore bidet completo di scarico Norton in metallo da 1"1/4. Serie Le Mans.

Cartuccia Ø40 mm.



04404.000		98,500	1
-----------	--	--------	---

**art. 4406**

Miscelatore doccia incasso. Serie Le Mans.

Cartuccia Ø40 mm.



04406.000		61,000	1
-----------	--	--------	---

**art. 4408**

Miscelatore doccia incasso con deviatore.  
Serie Le Mans.

Cartuccia Ø40 mm.

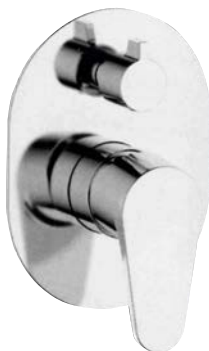

cod. art.	mis.	€	conf.
04408.000		129,000	1

**art. 4412**

Miscelatore per lavello canna ponte.  
Serie Le Mans.

Cartuccia Ø40 mm.



04412.000		92,500	1
-----------	--	--------	---

**Serie Charlotte**

**art. 4500**

Miscelatore vasca esterno completo di doccia duplex.  
Serie Charlotte.

Cartuccia Ø35 mm.

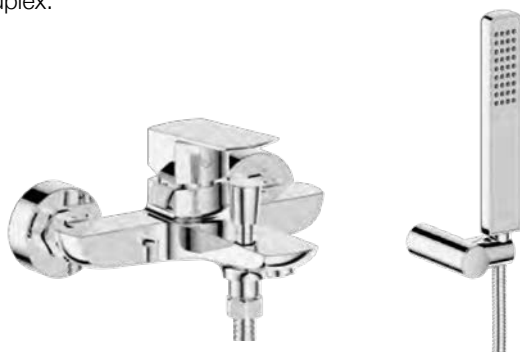

04500.000		182,800	1
-----------	--	---------	---

**art. 4502**

Miscelatore lavabo completo di piletta Click Clack in ottone da 1"1/4.  
Serie Charlotte.

Cartuccia Ø35 mm.



04502.000		125,000	1
-----------	--	---------	---

**art. 4503A**

Miscelatore lavabo alto completo di piletta Cick Clack in ottone da 1"1/4. Serie Charlotte.

Cartuccia Ø35 mm.



cod. art.	mis.	€	conf.
<b>4503A.000</b>		<b>205,000</b>	<b>1</b>

**art. 4504**

Miscelatore bidet completo di piletta Cick Clack in ottone da 1"1/4. Serie Charlotte.

Cartuccia Ø35 mm.



<b>04504.000</b>		<b>125,000</b>	<b>1</b>
------------------	--	----------------	----------

**art. 4510**

Miscelatore doccia esterno. Serie Charlotte.

Cartuccia Ø35 mm.



<b>04510.000</b>		<b>136,200</b>	<b>1</b>
------------------	--	----------------	----------

**art. 4506**

Miscelatore doccia incasso. Serie Charlotte.

Cartuccia Ø35 mm.



<b>04506.000</b>		<b>102,600</b>	<b>1</b>
------------------	--	----------------	----------

**art. 4508**

Miscelatore doccia incasso con deviatore. Serie Charlotte.

Cartuccia Ø35 mm.



<b>04508.000</b>		<b>182,800</b>	<b>1</b>
------------------	--	----------------	----------

**art. 4602**

Miscelatore lavabo in acciaio inox completo di piletta click clack in ottone da 1" 1/4. Serie Armonia.

cartuccia Ø35 mm.



cod. art.	mis.	€	conf.
04602.00		96,200	1

**art. 4604**

Miscelatore bidet in acciaio inox completo di piletta click clack in ottone da 1" 1/4. Serie Armonia.

cartuccia Ø35 mm.



04604.00		96,200	1
----------	--	--------	---

**art. 4606**

Miscelatore doccia incasso in acciaio inox. Serie Armonia.

cartuccia Ø35 mm.



04606.00		92,700	1
----------	--	--------	---

**art. 4608**

Miscelatore doccia incasso con deviatore in acciaio inox. Serie Armonia.

cartuccia Ø35 mm.

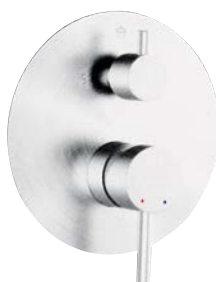

04608.00		155,700	1
----------	--	---------	---

**art. 4612**

Miscelatore lavello cucina canna ponte girevole in acciaio inox. Serie Armonia.

cartuccia Ø35 mm.



04612.00		93,000	1
----------	--	--------	---

**art. 4312**

Miscelatore lavabo cromato con doccia estraibile completo di piletta click clack in ottone da 1" 1/4.

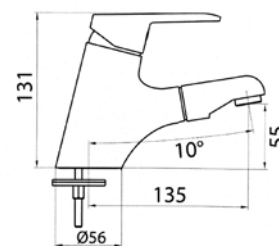
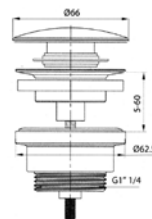

cod. art.	mis.	€	conf.
04312.00		133,000	1

**art. 4313**

Miscelatore lavello cucina canna squadrata.

Finitura: **cromata.**

cartuccia Ø 40mm



04313.00	cromo	77,900	1
----------	-------	--------	---

**art. 4314**

Miscelatore lavello cucina canna squadrata.

Finitura: **bianca opaca.**

Finitura: **nera opaca.**

cartuccia Ø 40mm



04314.03	bianca opaca	95,000	1
04314.05	nera opaca	95,000	1

**art. 4314**

Miscelatore lavello cucina  
canna squadrata.

Finitura: **Terra di Francia.**

Finitura: **Granito Avena.**

cartuccia Ø 40mm



cod. art.	mis.	€	conf.
04314.09	Terra di Francia	<b>95,000</b>	1
04314.10	Granito Avena	<b>95,000</b>	1

**art. 4314**

Miscelatore lavello cucina  
canna squadrata.

Finitura: **Rame.**

Finitura: **Bronzo.**

cartuccia Ø 40mm



04314.16	Rame	<b>95,000</b>	1
04314.18	Bronzo	<b>95,000</b>	1

**art. 4314**

Miscelatore lavello cucina  
canna squadrata.

Finitura: **Acciaio Spazzolato.**

cartuccia Ø 40mm



04314.34	Acciaio Spazz.	<b>95,000</b>	1
----------	----------------	---------------	---

## art. 7055

Testa termostatica universale  
a liquido completa di 6 adattatori.

**Prodotto certificato EN215.**

### Caratteristiche tecniche:

Materiale: ABS

Attacco filettatura: M30x1,5

Campo di regolazione temperatura: 6÷28°C

Temperatura di stoccaggio: -20÷45°C

Pressione massima differenziale: 0,8 bar

Tempo di risposta: 30 min.

Isteresi: 0,5 K

Influenza pressione differenziale: 0,3 K

### Adattatori compatibili con valvole

- CALEFFI

- GIACOMINI

- DANFOSS

- Filetto: M28x1,5 mm



cod. art.	mis.	€	conf.
07055.000	M30x1,5	19,500	10

### Regolazione della temperatura:

La corretta posizione di regolazione della testa termostatica si ottiene facendo riferimento alla tabella che abbina la numerazione presente sulla manopola della testa.

Posizione testa termostatica *	1	2	3	4	5
Temperatura regolata (°C)	6	12	16	20	28

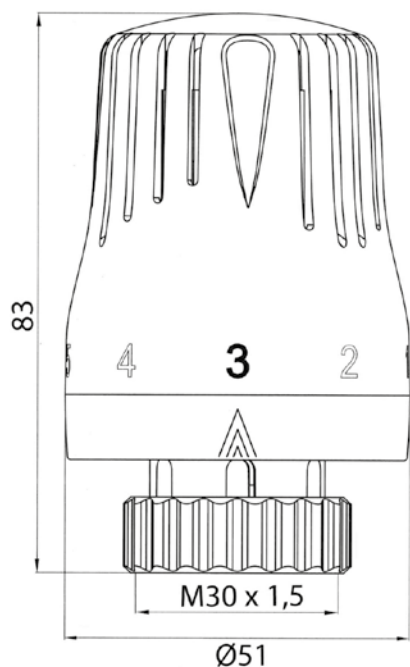

### COMPATIBILITÀ ADATTATORI

<p>CALEFFI</p>	<p>H8.6mm GIACOMINI</p>
<p>DANFOSS MODELLO RA</p>	<p>H13mm DANFOSS MODELLO RAV</p>
<p>DANFOSS MODELLO RAVL</p>	<p>H17.3mm H18.8mm H15.3mm H24.3mm FILETTO M28 x 1,5mm</p>

### art. 1537A

Piletta basket per lavelli con foro Ø 90 mm. Scarico filettato da 1"1/2. Corpo piletta in polipropilene PP bianco, flangia e cestello in acciaio inox 18/8 Ø 115. Versione senza troppo pieno.



cod. art.	mis.	€	conf.
1537A.000		9,000	5

### art. 1538A

Piletta basket per lavelli con foro Ø 90 mm. (3"1/2). Scarico filettato da 1"1/2. Corpo piletta in polipropilene PP bianco, flangia e cestello in acciaio inox 18/8 Ø 115. Versione con troppo pieno flessibile dotato di griglia rettangolare in acciaio inox per lavelli in resina.



1538A.000		12,100	5
-----------	--	--------	---

### art. 1537C.ALB

Cestello ricambio per nostri articoli 1537A e 1538A.

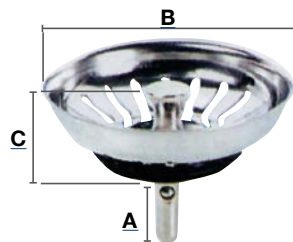

1537C.ALB		6,003	10
A 26 mm B 79 mm C 17 mm			

## XLIRA

### art. 701

TEE antirumore per connessione a lavatrici / lavastoviglie.



00701.000	1"1/2	17,600	2
-----------	-------	--------	---

### art. 7112A

Tappo saltarello universale Click click in ottone nero.



07112A.NER		19,000	2
------------	--	--------	---



**art. 810**

 Portagomma curvo  
 PP D.40 Uscita 25/20

cod. art.	mis.	€	conf.
00810.040		1,520	10

**art. 811**

 Portagomma dritto  
 PP D.40 Uscita 25/20

00811.040		1,400	10
-----------	--	-------	----

**art. 812**

 Tappo PP verde  
 per ghiera D.40

00812.040		0,420	10
-----------	--	-------	----

**art. 814**

 Ghiera filettata  
 PP bianca D.40

00814.040		0,600	10
-----------	--	-------	----

**art. 815**

 Kit raccordi  
 lavatrice / lavastoviglie  
 Confezione in sacchetto.

00815.KIT		3,900	10
-----------	--	-------	----

**art. 1227B**

Sifone a "S" in P.P.



1227B.BIA	1"1/4x32	9,500	5
-----------	----------	-------	---

**art. 1228B**

Sifone a "U" in P.P.



1228B.BIA	1"1/4x32	9,800	5
-----------	----------	-------	---

**art. 270SP**

Dado e curvetta sede piana in ABS bianca per lavatrice.



cod. art.	mis.	€	conf.
<b>270SP.BIA</b>		<b>2,970</b>	10

**art. 271SP**

Dado e curvetta sede piana in ABS bianca per asciugatrice.



<b>271SP.BIA</b>		<b>3,200</b>	10
------------------	--	--------------	----

**art. 8830T**

Doppio attacco lavatrice con ghiera girevole in ottone cromato.

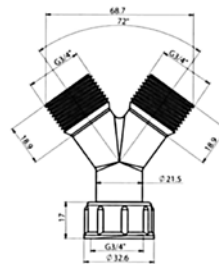

<b>8830T.000</b>	3/4"x3/4"	<b>15,700</b>	5
------------------	-----------	---------------	---

**art. 1527B**

Piletta Click clack universale in ottone a doppia funzione. (corpo più basso)



<b>1527B.UNI</b>	1"1/4	<b>18,800</b>	5
------------------	-------	---------------	---

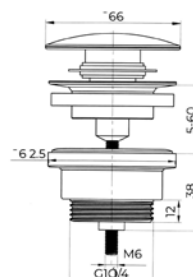

**art. 7252A**

Dosatore Dox in linea.  
 Dosatore di polifosfato.  
 Attacchi: ghiera girevoli 1/2 F.  
 Portata massima: 1,5 mc/h  
 Pressione d'esercizio: 5 bar  
 Ingombro con montaggio in verticale:  
 158 (H) x 66 mm  
 Chiavi per ghiera + guarnizioni incluse



cod. art.	mis.	€	conf.
<b>7252A.000</b>		<b>110,000</b>	1

**art. 837**

Dosatore Nano.  
 Micro dosatore di polifosfato.  
 Può essere installato sia in posizione verticale (consigliata) che in posizione orizzontale.  
 Attacchi: ghiera girevoli 1/2 F.  
 Portata massima: 1,5 mc/h  
 Pressione d'esercizio: 5 bar  
 Ingombro con montaggio in verticale:  
 110 (H) x 46mm  
 Chiavi per ghiera + guarnizioni incluse



00837.000		<b>60,000</b>	1
0837C.RIC	4 pezzi	<b>14,000</b>	1

**art. 837C**

Ricarica Stick per dosatore Nano.

**art. 7233A**

Nuovo Kit caldaia  
 Dosatore - defangatore  
 e neutralizzatore.



<b>7233A.KIT</b>		<b>183,414</b>	2
------------------	--	----------------	---

**art. 852CF**

Kit 4 pezzi polifosfato  
 per dosatori da 3/4.



<b>852CF.304</b>		<b>33,000</b>	1
------------------	--	---------------	---

**art. 1804**

Tubo PVC trasparente per scarico condensa rotoli da 25 m.



cod. art.	mis.	€	conf.
01804.006	Ø6 x 9	<b>2,500</b>	25
01804.010	Ø10 x 14	<b>3,300</b>	25

Prezzo al metro

**PUCCI®**

**art. 82009**

Tubicino ricambio trasparente per pulsanti Pneu mt. 3



<b>82009.923</b>	<b>5,000</b>	1
------------------	--------------	---

**art. 1801H**

Cassetta di predisposizione HYDRONIC BOX  
Uscita scarico orizzontale e verticale reversibile DX - SX.



<b>1801H.BOX</b>	<b>42,000</b>	1
------------------	---------------	---

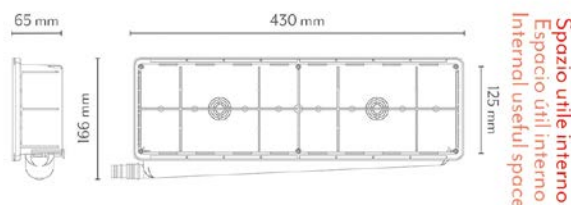
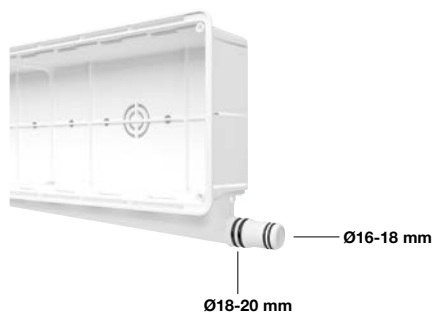

**art. 1642P**

Batteria universale pneumatica corpo in plastica per cassette in ceramica monoblocco, pulsante in ABS cromato.

**MADE IN ITALY**



<b>1642P.PLA</b>	<b>50,000</b>	1
------------------	---------------	---

### art. **887VAP**

Guarnizioni per flange  
in grafite senza fori 2 mm - PN 10-16  
Ideale per impieghi ad alta temperatura  
e pressione, in presenza di vapore  
saturato e surriscaldato.  
550°C - Pressione MAX 40/120°C  
Spessore 2mm



**N.B.**  
**Disponibile anche con armatura**  
**(Prezzo su richiesta)**

cod. art.	mis.	€	conf.
<b>887VAP.001</b>	DN 15	<b>1,250</b>	50
<b>887VAP.002</b>	DN 20	<b>1,520</b>	50
<b>887VAP.003</b>	DN 25	<b>1,930</b>	50
<b>887VAP.004</b>	DN 32	<b>2,900</b>	50
<b>887VAP.005</b>	DN 40	<b>3,200</b>	50
<b>887VAP.006</b>	DN 50	<b>4,000</b>	50
<b>887VAP.007</b>	DN 65	<b>6,000</b>	50
<b>887VAP.008</b>	DN 80	<b>6,400</b>	50
<b>887VAP.009</b>	DN 100	<b>7,000</b>	50
<b>887VAP.010</b>	DN 125	<b>10,300</b>	50
<b>887VAP.011</b>	DN 150	<b>11,500</b>	50
<b>887VAP.012</b>	DN 200	<b>17,000</b>	50
<b>887VAP.013</b>	DN 250	<b>20,100</b>	50
<b>887VAP.014</b>	DN 300	<b>37,300</b>	50

### art. **1443**

Guarnizione per raccordo in TESNIT.  
Materiale sviluppato per le nuove normative  
per acqua potabile BWGL KTW.  
Omologato per contatto alimenti secondo  
FDA ed EU1935/2004.  
Idoneo per l'utilizzo con gas.  
Materiale: ID 326  
Spessore: 2mm



<b>01443.002</b>	3/8"	<b>9,000</b>	(x100)
<b>01443.003</b>	1/2"	<b>12,700</b>	(x100)
<b>01443.004</b>	3/4"	<b>22,700</b>	(x100)
<b>01443.005</b>	1"	<b>31,200</b>	(x100)
<b>01443.006</b>	1"1/4	<b>38,000</b>	(x100)
<b>01443.007</b>	1"1/2	<b>47,000</b>	(x100)

### art. **1442**

Guarnizioni fibra rossa SP 1,5



<b>01442.002</b>	3/8"	<b>2,300</b>	(x100)
<b>01442.003</b>	1/2"	<b>2,700</b>	(x100)
<b>01442.004</b>	3/4"	<b>3,200</b>	(x100)
<b>01442.005</b>	1"	<b>5,000</b>	(x100)
<b>01442.006</b>	1"1/4	<b>6,100</b>	(x100)
<b>01442.007</b>	1"1/2	<b>8,100</b>	(x100)
<b>01442.008</b>	2"	<b>45,300</b>	(x100)

### art. **0785A**

Morsetto nero per scarico condensa.



<b>0785A.000</b>	32x8/14	<b>0,900</b>	100
------------------	---------	--------------	-----

## CARATTERISTICHE

Valvole a sfera modello "New Jersey" in ottone a passaggio totale.

Filetto ISO 228/1 a Norma EN 12828

Limiti di temperatura: -20°C +120°C

Limiti di pressione: PN14÷PN50

### art. 7912

Femmina/Femmina leva alluminio rossa

DN	G	A	B	C	D	Ch	PN
15	1/2"	48.5	49	87.5	9	25	50
20	3/4"	56	56	87.5	10.5	31	30
25	1"	68	63	99	12.5	38	30
32	1 1/4"	79	68	131.5	14.5	47	20
40	1 1/2"	94	75	131.5	15.5	54	20
50	2"	107	91	154	17.5	66	20
65	2 1/2"	128	130	190	20	82	18

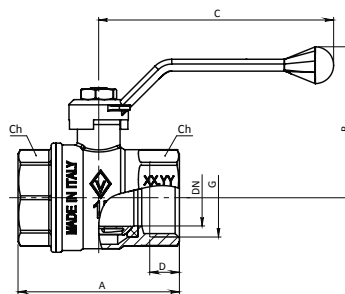

cod. art.	mis.	€	conf.
<b>DN G</b>			
07912.012	15 1/2"	<b>9,950</b>	20
07912.034	20 3/4"	<b>14,650</b>	14
07912.100	25 1"	<b>22,300</b>	6
07912.114	32 1 1/4"	<b>34,850</b>	4
07912.112	40 1 1/2"	<b>52,400</b>	2
07912.200	50 2"	<b>81,000</b>	2
07912.212	65 2 1/2"	<b>190,000</b>	1

### art. 7913

Maschio/Femmina leva alluminio rossa.

DN	G	A	B	C	D	E	Ch1	Ch2	PN
15	1/2"	56.5	49	87.5	9	9	22	22	50
20	3/4"	64	56	87.5	10	10	28	28	30
25	1"	77	63	99	14	14	35	35	30
32	1 1/4"	90.5	68	131.5	15	15	43	43	20
40	1 1/2"	102.5	75	131.5	17	17	49	49	20
50	2"	117	91	154	19	19	61	61	20

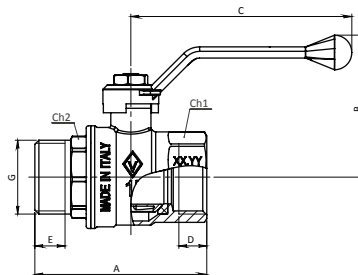

<b>DN G</b>			
07913.012	15 1/2"	<b>10,900</b>	20
07913.034	20 3/4"	<b>15,900</b>	14
07913.100	25 1"	<b>24,000</b>	6
07913.114	32 1 1/4"	<b>38,400</b>	4
07913.112	40 1 1/2"	<b>56,600</b>	2
07913.200	50 2"	<b>86,800</b>	1

### art. 7914

Femmina/Femmina farfalla alluminio rossa.

DN	G	A	B	C	D	Ch	PN
15	1/2"	48.5	40.5	53	9	25	50
20	3/4"	56	47	63	10.5	31	30
25	1"	68	55	63	12.5	38	30
32	1 1/4"	79	60	73	14.5	47	20

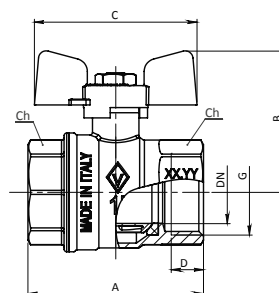

<b>DN G</b>			
07914.012	15 1/2"	<b>9,800</b>	24
07914.034	20 3/4"	<b>14,100</b>	14
07914.100	25 1"	<b>21,900</b>	10
07914.114	32 1 1/4"	<b>35,540</b>	6

## CARATTERISTICHE

Valvole a sfera modello "New Jersey" in ottone a passaggio totale.

Filetto ISO 228/1 a Norma EN 12828

Limiti di temperatura: -20°C +120°C

Limiti di pressione: PN14÷PN50

### art. 7915

Maschio/Femmina farfalla alluminio rossa.

DN	G	A	B	C	D	E	Ch1	Ch2	PN
15	1/2"	56.5	40.5	53	9	9	25	22	50
20	3/4"	64	47	63	10.5	10	31	28	30
25	1"	77	55	63	12.5	14	38	35	30
32	1"1/4"	90.5	60	73	14.5	15	47	43	20

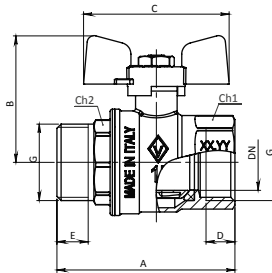

cod. art.	mis.		€	conf.
	DN	G		
07915.012	15	1/2"	10,700	20
07915.034	20	3/4"	15,500	14
07915.100	25	1"	23,700	8
07915.114	32	1"1/4"	39,300	1

### art. 7916

Femmina/bocchettone leva alluminio rossa.



	DN	G		
07916.012	15	1/2"	14,900	14
07916.034	20	3/4"	21,700	8
07916.100	25	1"	33,300	6
07916.114	32	1"1/4"	51,950	4
07916.112	40	1"1/2"	81,800	2
07916.200	50	2"	125,000	1

### art. 7917

Femmina/bocchettone farfalla alluminio rossa.



	DN	G		
07917.012	15	1/2"	14,700	14
07917.034	20	3/4"	21,200	10
07917.100	25	1"	33,900	6
07917.114	32	1"1/4"	53,200	4

## CARATTERISTICHE

Valvole a sfera modello **"California"** in ottone a passaggio totale.

**Filetto ISO 7/1 UNI EN 10226 a Norma 13828**

Limiti di temperatura: -20°C +120°C

Limiti di pressione: PN14÷PN64

### art. 7920

Femmina/Femmina leva alluminio nera

DN	Rp	A	B	C	D	Ch	PN
15	1/2"	58	48	87.5	15	25	64
20	3/4"	66	52	87.5	16.3	31	40
25	1"	80	63	131.5	19.1	38	40
32	1"1/4	93	69	131.5	21.4	48	25
40	1"1/2	104	86	154	21.4	54	25
50	2"	123	93	154	25.7	67	25
65	2"1/2	147	130	190	30.2	82	18

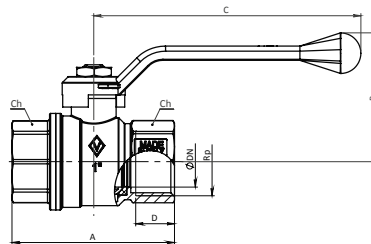

cod. art.	mis.		€	conf.
	DN	Rp		
07920.012	15	1/2"	<b>12,500</b>	20
07920.034	20	3/4"	<b>18,250</b>	14
07920.100	25	1"	<b>27,800</b>	6
07920.114	32	1"1/4	<b>43,600</b>	4
07920.112	40	1"1/2	<b>65,700</b>	2
07920.200	50	2"	<b>101,300</b>	1
07920.212	65	2"1/2	<b>260,500</b>	1

### art. 7921

Maschio/Femmina leva alluminio nera.

DN	R-Rp	A	B	C	D	E	Ch1	Ch2	PN
15	1/2"	68	48	87.5	15	13.5	25	22	64
20	3/4"	75	52	87.5	16.3	15	31	28	40
25	1"	88.5	63	131.5	19.1	18.5	38	35	40
32	1"1/4	102.5	69	131.5	21.4	19.1	48	43	25
40	1"1/2	109.5	86	154	21.4	19.1	54	54	25
50	2"	130.5	93	154	25.7	23.4	67	61	25

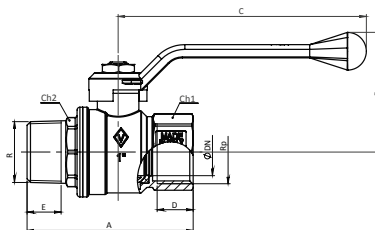

	DN	R-Rp		
07921.012	15	1/2"	<b>13,600</b>	20
07921.034	20	3/4"	<b>20,100</b>	12
07921.100	25	1"	<b>30,100</b>	6
07921.114	32	1"1/4	<b>48,100</b>	4
07921.112	40	1"1/2	<b>70,100</b>	2
07921.200	50	2"	<b>108,400</b>	1

### art. 7922

Femmina/Femmina farfalla alluminio nero.

DN	Rp	A	B	C	D	Ch	PN
15	1/2"	58	40.5	53	15	25	64
20	3/4"	66	47	63	16.3	31	40
25	1"	80	55	73	19.1	38	40
32	1"1/4	93	60.5	73	21.4	48	25

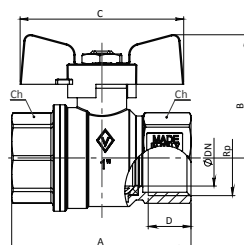

	DN	Rp		
07922.012	15	1/2"	<b>12,300</b>	24
07922.034	20	3/4"	<b>17,700</b>	14
07922.100	25	1"	<b>27,300</b>	6
07922.114	32	1"1/4	<b>44,600</b>	4

## CARATTERISTICHE

Valvole a sfera modello "California" in ottone a passaggio totale.

Filetto ISO 7/1 UNI EN 10226 a Norma 13828

Limiti di temperatura: -20°C +120°C

Limiti di pressione: PN14÷PN64

### art. 7923

Maschio/Femmina farfalla alluminio nero.

DN	Rp	A	B	C	D	E	Ch1	Ch2	PN
15	1/2"	68	40.5	23	15	13.5	25	22	64
20	3/4"	75	47	63	16.3	15	31	28	40
25	1"	88.5	55	73	19.1	18.5	38	35	40
32	1"1/4"	102.5	50.5	73	21.4	19.1	48	43	25

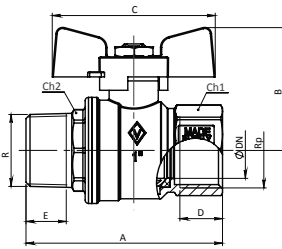

cod. art.	mis.		€	conf.
-----------	------	--	---	-------

	DN	R-Rp		
07923.012	15	1/2"	13,600	20
07923.034	20	3/4"	19,350	12
07923.100	25	1"	29,700	6
07923.114	32	1"1/4"	49,400	4

### art. 7924

Femmina/dado mobile farfalla alluminio nera.



	DN	Rp	G	
07924.012	15	1/2"	3/4"	16,600
07924.034	15	3/4"	3/4"	17,500

### art. 7925

Maschio/dado mobile farfalla alluminio nera.



	DN	R	G	
07925.012	15	1/2"	3/4"	18,200
07925.034	15	3/4"	3/4"	19,000

### art. 7926

Angolo Femmina/dado mobile farfalla alluminio nera.



	DN	Rp	G	
07926.012	15	1/2"	3/4"	18,800
07926.034	15	3/4"	3/4"	19,700

### art. 7927

Angolo Maschio/dado mobile farfalla alluminio nera.



	DN	R	G	
07927.012	15	1/2"	3/4"	20,500
07927.034	15	3/4"	3/4"	21,600

## CARATTERISTICHE

Mini valvole "Utah" in ottone a passaggio totale.

Filetto ISO 228/1 a Norma EN 12828

Limiti di temperatura: -20°C +90°C

Limiti di Pressione: PN10

### art. 414BG

Minivalvola femmina/femmina sabbiata e nichelata leva alluminio.



cod. art.	mis.		€	conf.
	DN	G		
414BG.014	8	1/4"	7,310	50
414BG.038	8	3/8"	7,100	50
414BG.012	10	1/2"	8,850	40

### art. 415BG

Minivalvola maschio/femmina sabbiata e nichelata leva alluminio.



LEVA NERA	DN	G		
415BG.014	8	1/4"	7,100	50
415BG.038	8	3/8"	6,800	50
415BG.012	10	1/2"	8,850	40

### art. 528P.BG

Rubinetto sottolavabo a sfera con snodo, filtro e rosetta, leva in ABS cromato.



	DN	R		
0528P.BGO	8	1/2"x ø10	14,800	30

### art. 532P.BG

Rubinetto sottolavabo a sfera con filtro e rosetta, leva in ABS cromato.



	DN	R		
0532P.BGO	8	1/2"x 3/8"	13,400	30

### art. 7930

Rubinetto pesante con portagomma leva alluminio nera.



07930.012	1/2"	14,800	10
07930.034	3/4"	20,300	8

## CARATTERISTICHE

Valvole a sfera per GAS "Colorado"

in ottone a passaggio totale.

Filetto ISO 7/1 UNI EN 10226 a Norma EN331

Limiti di temperatura: -20°C +60°C

Limiti di Pressione: MOP5

### art. 680BG

Femmina/femmina leva acciaio.

DN	Rp	A	B	C	D	Ch	PN
15	1/2"	58	41	85	15	25	MOP5
20	3/4"	66	44	96.5	16.3	31	MOP5
25	1"	80	53	120	19.1	38	MOP5
32	1 1/4"	93	59	120	21.4	48	MOP5
40	1 1/2"	104	76	162	21.4	54	MOP5
50	2"	123	83	162	25.7	67	MOP5
65	2 1/2"	147	130	190	30.2	82	MOP5
80	3"	170	142	229	33.3	96	MOP5
100	4"	204	157	229	39.3	122	MOP5

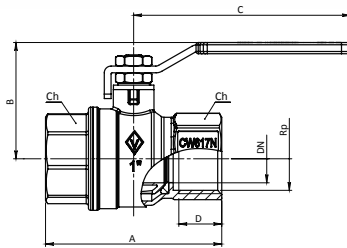

cod. art.	mis.		€	conf.
	DN	Rp		
680BG.012	15	1/2"	13,500	20
680BG.034	20	3/4"	19,900	12
680BG.100	25	1"	30,250	6
680BG.114	32	1 1/4"	47,350	4
680BG.112	40	1 1/2"	71,300	2
680BG.200	50	2"	110,000	1
680BG.212	65	2 1/2"	286,000	1
680BG.300	80	3"	425,000	1
680BG.400	100	4"	757,000	1

### art. 681BG

Femmina/femmina farfalla alluminio.

DN	Rp	A	B	C	D	Ch	PN
15	1/2"	58	40.5	53	15	25	MOP5
20	3/4"	66	47	63	16.3	31	MOP5
25	1"	80	55	73	19.1	38	MOP5
32	1 1/4"	93	60.5	73	21.4	48	MOP5

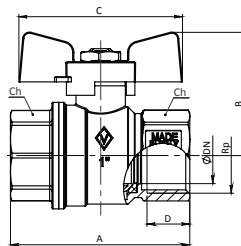

	DN	Rp	€	
681BG.012	15	1/2"	13,400	24
681BG.034	20	3/4"	19,200	14
681BG.100	25	1"	29,800	6
681BG.114	32	1 1/4"	48,200	4

### art. 682BG

Maschio/femmina leva acciaio.

DN	R-Rp	A	B	C	D	E	Ch1	Ch2	PN
15	1/2"	68	41	85	15	13.5	25	22	MOP5
20	3/4"	75	44	96.5	16.3	15	31	28	MOP5
25	1"	88.5	53	120	19.1	18.5	38	35	MOP5
32	1 1/4"	102.5	59	120	21.4	19.1	48	43	MOP5
40	1 1/2"	109.5	76	162	21.4	19.1	54	54	MOP5
50	2"	130.5	83	162	25.7	23.4	67	61	MOP5

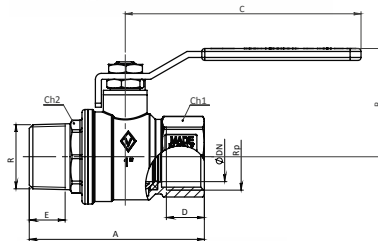

	DN	Rp	€	
682BG.012	15	1/2"	14,800	20
682BG.034	20	3/4"	21,550	12
682BG.100	25	1"	32,700	6
682BG.114	32	1 1/4"	52,200	4
682BG.112	32	1 1/2"	76,500	2
682BG.200	32	2"	117,700	1

### art. 683BG

Femmina/femmina farfalla alluminio.

DN	R-Rp	A	B	C	D	E	Ch1	Ch2	PN
15	1/2"	68	40.5	53	15	13.5	25	22	MOP5
20	3/4"	75	47	63	16.3	15	31	28	MOP5
25	1"	88.5	55	73	19.1	18.5	38	35	MOP5
32	1 1/4"	102.5	60.5	73	21.4	19.1	48	43	MOP5

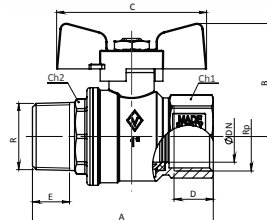

	DN	Rp	€	
683BG.012	15	1/2"	14,550	20
683BG.034	20	3/4"	21,100	12
683BG.100	25	1"	32,200	6
683BG.114	32	1 1/4"	52,450	4

**art. 1233**

Raccordo estensibile ruotabile ideale per giunzioni o riparazioni in spazi ristretti.  
MF 1/2" 100/150

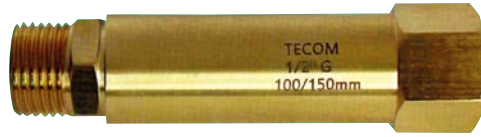

cod. art.	mis.	€	conf.
01233.100	MF 1/2" 100/150	13,900	10

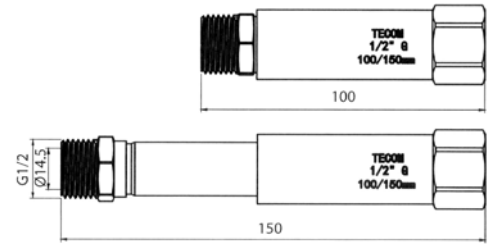

**art. 1233A**

Raccordo estensibile ruotabile ideale per giunzioni o riparazioni in spazi ristretti.  
MF 1/2" 150/250

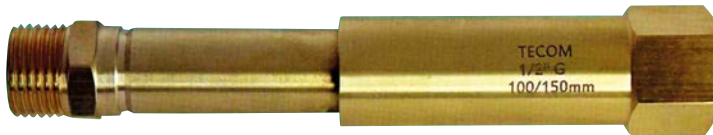

1233A.150	MF 1/2" 150/250	21,000	10
-----------	-----------------	--------	----

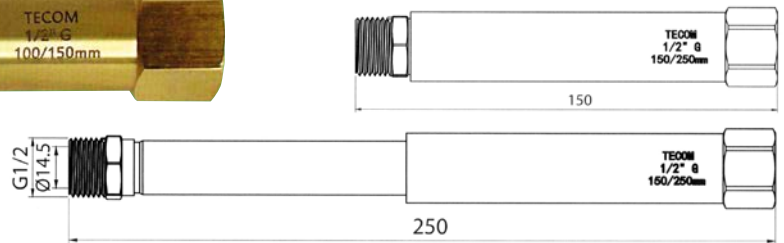

**art. 1234**

Raccordo estensibile ruotabile ideale per giunzioni o riparazioni in spazi ristretti.  
MF 1/2" 100/150



01234.100	MF 3/4" 100/150	23,800	10
-----------	-----------------	--------	----

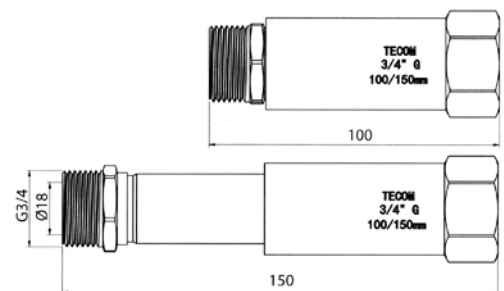

**art. 1234A**

Raccordo estensibile ruotabile ideale per giunzioni o riparazioni in spazi ristretti.  
MF 1/2" 150/250

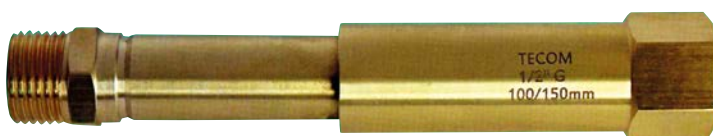

1233A.150	MF 3/4" 150/250	37,000	10
-----------	-----------------	--------	----

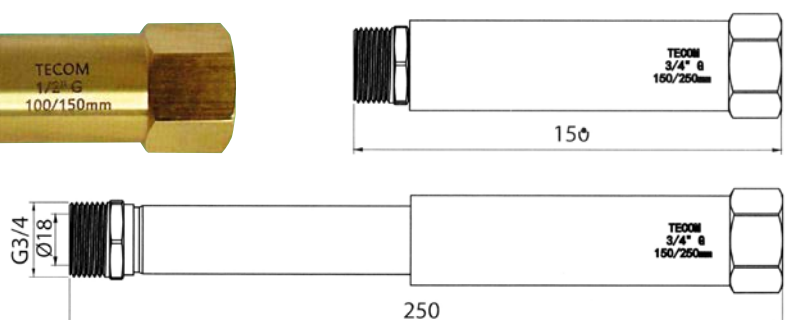







**art. 7666**

 Giunto di Riparazione  
per Tubi Multistrato.

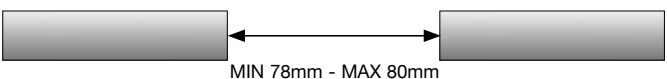
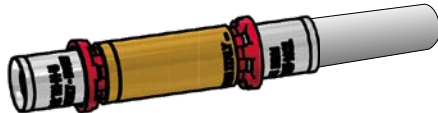
cod. art.	mis.	€	conf.
07666.016	16X16	<b>23,800</b>	1
07666.020	20X20	<b>26,100</b>	1

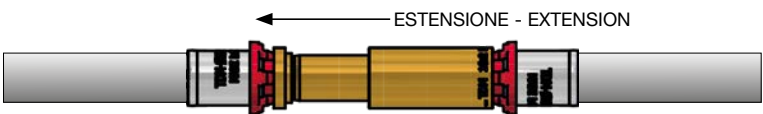

1	<b>PERDITA ACQUA</b> WATER LOSS	
2	<b>TAGLIO DEL TUBO</b> PIPE CUTTING 	
3	<b>INSERIMENTO RACCORDO PRIMO LATO</b> INSERTING THE FIRST SIDE SETTING	
4	<b>INSERIMENTO RACCORDO SECONDO LATO</b> INSERTING THE SECOND SIDE SETTING	
5	<b>ESTENSIONE DEL RACCORDO TELESCOPICO</b> EXTENSION OF THE TELESCOPIC CONNECTION	
6	<b>PRESSATURA</b> PRESSING 	

### art. 1459

Curveta in ottone cromato stampata con 90° inclinazione senza dado.



cod. art.	mis.	€	conf.
01459.000	1/2"x3/8"	7,600	50

### art. 75X

Tubo flessibile in gomma EPDM e in treccia acciaio inox 8 fili - DN10 Maschio normale / Dado esagonale con guarnizione inserita.

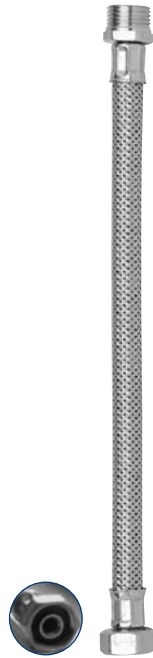

0075X.002	3/8"x3/8"x20	4,780	20
0075X.003	3/8"x3/8"x25	5,000	20
0075X.004	3/8"x3/8"x30	5,250	20
0075X.005	3/8"x3/8"x35	5,450	20
0075X.006	3/8"x3/8"x40	5,670	20
0075X.007	3/8"x3/8"x50	6,100	20
0075X.008	3/8"x3/8"x60	6,550	20
0075X.009	1/2"x3/8"x20	4,780	20
0075X.010	1/2"x3/8"x25	5,000	20
0075X.011	1/2"x3/8"x30	5,250	20
0075X.012	1/2"x3/8"x35	5,450	20
0075X.013	1/2"x3/8"x40	5,670	20
0075X.014	1/2"x3/8"x50	6,100	20
0075X.015	1/2"x3/8"x60	6,550	20
0075X.016	3/8"x1/2"x20	4,780	20
0075X.017	3/8"x1/2"x25	5,000	20
0075X.018	3/8"x1/2"x30	5,250	20
0075X.019	3/8"x1/2"x35	5,450	20
0075X.020	3/8"x1/2"x40	5,670	20
0075X.021	3/8"x1/2"x50	6,100	20
0075X.022	3/8"x1/2"x60	6,550	20
0075X.023	1/2"x1/2"x20	4,780	20
0075X.024	1/2"x1/2"x25	5,000	20
0075X.025	1/2"x1/2"x30	5,250	20
0075X.026	1/2"x1/2"x35	5,450	20
0075X.027	1/2"x1/2"x40	5,670	20
0075X.028	1/2"x1/2"x50	6,100	20
0075X.029	1/2"x1/2"x60	6,550	20

### art. 75XFF

Tubo flessibile in gomma EPDM e in treccia acciaio inox 8 fili - DN10 Dado esagonale / Dado esagonale con guarnizioni inserite.

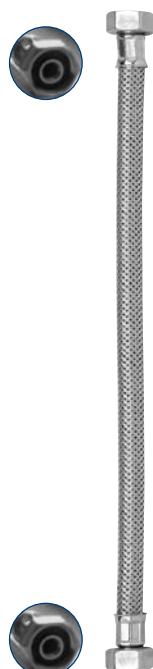

75XFF.002	3/8"x3/8"x20	4,780	20
75XFF.003	3/8"x3/8"x25	5,000	20
75XFF.004	3/8"x3/8"x30	5,250	20
75XFF.005	3/8"x3/8"x35	5,450	20
75XFF.006	3/8"x3/8"x40	5,670	20
75XFF.007	3/8"x3/8"x50	6,100	20
75XFF.008	3/8"x3/8"x60	6,550	20
75XFF.010	3/8"x1/2"x20	4,780	20
75XFF.011	3/8"x1/2"x25	5,000	20
75XFF.012	3/8"x1/2"x30	5,250	20
75XFF.013	3/8"x1/2"x35	5,450	20
75XFF.014	3/8"x1/2"x40	5,670	20
75XFF.015	3/8"x1/2"x50	6,100	20
75XFF.016	3/8"x1/2"x60	6,550	20
75XFF.018	1/2"x1/2"x20	4,780	20
75XFF.019	1/2"x1/2"x25	5,000	20
75XFF.020	1/2"x1/2"x30	5,250	20
75XFF.021	1/2"x1/2"x35	5,450	20
75XFF.022	1/2"x1/2"x40	5,670	20
75XFF.023	1/2"x1/2"x50	6,100	20
75XFF.024	1/2"x1/2"x60	6,550	20

**art. 75XNL**

Tubo flessibile in gomma EPDM e in treccia acciaio inox 8 fili - DN10 Maschio prolungato/Dado esagonale **con guarnizione inserita.**

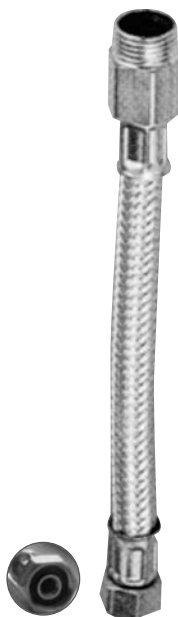

cod. art.	mis.	€	conf.
75XNL.002	3/8"x3/8"x20	5,900	20
75XNL.003	3/8"x3/8"x25	6,100	20
75XNL.004	3/8"x3/8"x30	6,350	20
75XNL.005	3/8"x3/8"x35	6,560	20
75XNL.006	3/8"x3/8"x40	7,000	20
75XNL.007	3/8"x3/8"x50	7,450	20
75XNL.008	3/8"x3/8"x60	7,650	20
75XNL.010	1/2"x3/8"x20	5,900	20
75XNL.011	1/2"x3/8"x25	6,100	20
75XNL.012	1/2"x3/8"x30	6,350	20
75XNL.013	1/2"x3/8"x35	6,560	20
75XNL.014	1/2"x3/8"x40	7,000	20
75XNL.015	1/2"x3/8"x50	7,450	20
75XNL.016	1/2"x3/8"x60	7,650	20
75XNL.018	3/8"x1/2"x20	5,900	20
75XNL.019	3/8"x1/2"x25	6,100	20
75XNL.020	3/8"x1/2"x30	6,350	20
75XNL.021	3/8"x1/2"x35	6,560	20
75XNL.022	3/8"x1/2"x40	7,000	20
75XNL.023	3/8"x1/2"x50	7,450	20
75XNL.024	3/8"x1/2"x60	7,650	20
75XNL.026	1/2"x1/2"x20	5,900	20
75XNL.027	1/2"x1/2"x25	6,100	20
75XNL.028	1/2"x1/2"x30	6,350	20
75XNL.029	1/2"x1/2"x35	6,560	20
75XNL.030	1/2"x1/2"x40	7,000	20
75XNL.031	1/2"x1/2"x50	7,450	20
75XNL.032	1/2"x1/2"x60	7,650	20
75GEB.000	3/8"x3/8"x20	7,700	20

**art. 75GEB**

Tubo flessibile in gomma per ricambi cassette in treccia acciaio inox 9 fili - DN10 Dado esagonale/Femmina Curva **con guarnizioni inserite.** Tipo GEBERIT.

**art. 1008A**

Manichetta per gas bombola tubo arancio 8x15 senza rivestimento inox con raccordi 1/2"x1/2" in AVP.



1008A.040	40 cm	8,000	6
1008A.050	50 cm	8,350	6
1008A.060	60 cm	8,670	6
1008A.080	80 cm	9,300	6
1008A.100	100 cm	9,900	6

### art. 6342F

Vite doppia in ottone giallo  
sede piana, serie Fugazzola.



cod. art.	mis.	€	conf.
6342F.102	1/2"	4,150	10
6342F.304	3/4"	6,250	10
6342F.100	1"	12,350	10

### art. 451F

Bocchettone in ottone giallo  
con OR M. F.  
Serie Fugazzola.



0451F.001	1/2"	5,370	5
0451F.002	3/4"	8,420	5
0451F.003	1"	14,910	5
0451F.004	1"1/4	19,430	2
0451F.005	1"1/2	31,910	2
0451F.006	2"	55,100	1

### art. 7650

Raccordo diritto maschio a pressare  
per tubo multistrato multipinza  
profilo TH-H.



07650.001	1/2"x16	3,330	10
07650.002	1/2"x20	4,200	10
07650.003	3/4"x20	5,350	10
07650.004	3/4"x26	6,130	5
07650.005	1"x26	8,920	5
07650.006	1"x32	9,270	5

### art. 7651

Raccordo diritto femmina a pressare  
per tubo multistrato multipinza  
profilo TH-H.

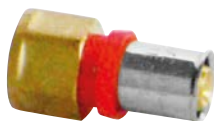

07651.001	1/2"x16	3,500	10
07651.002	1/2"x20	4,240	10
07651.003	3/4"x20	5,400	10
07651.004	3/4"x26	6,710	5
07651.005	1"x26	8,750	5
07651.006	1"x32	10,150	5

### art. 7652

Raccordo diritto doppio a pressare  
per tubo multistrato multipinza  
profilo TH-H.



07652.001	16x16	3,330	10
07652.002	20x20	4,550	10
07652.003	26x26	6,480	5
07652.004	32x32	9,550	5

### art. 7653

Raccordo diritto doppio ridotto  
a pressare per tubo multistrato  
multipinza profilo TH-H.



07653.001	20x16	4,900	10
07653.002	26x20	7,000	5
07653.003	32x26	10,150	5

**art. 7654**

Raccordo curvo doppio a pressare per tubo multistrato multipinza profilo TH-H.



cod. art.	mis.	€	conf.
07654.001	16x16	<b>5,250</b>	10
07654.002	20x20	<b>7,380</b>	10
07654.003	26x26	<b>11,370</b>	5
07654.004	32x32	<b>16,450</b>	5

**art. 7655**

Raccordo curvo maschio a pressare per tubo multistrato multipinza profilo TH-H.



07655.001	1/2"x16	<b>4,580</b>	10
07655.002	1/2"x20	<b>6,480</b>	10
07655.003	3/4"x20	<b>7,620</b>	10
07655.004	3/4"x26	<b>10,050</b>	5
07655.005	1"x26	<b>12,390</b>	5
07655.006	1"x32	<b>15,220</b>	5

**art. 7656**

Raccordo curvo femmina a pressare per tubo multistrato multipinza profilo TH-H.



07656.001	1/2"x16	<b>4,580</b>	10
07656.002	1/2"x20	<b>6,480</b>	10
07656.003	3/4"x20	<b>7,620</b>	10
07656.004	3/4"x26	<b>10,050</b>	5
07656.005	1"x26	<b>12,400</b>	5
07656.006	1"x32	<b>15,220</b>	5

**art. 7657**

Raccordo curvo flangiato femmina a pressare per tubo multistrato multipinza profilo TH-H.



07657.001	1/2"x16	<b>6,270</b>	10
07657.002	1/2"x20	<b>8,080</b>	10
07657.003	3/4"x20	<b>10,090</b>	10

**art. 7658**

Dima completa di raccordi a pressare per tubo multistrato multipinza profilo TH-H.



07658.001	1/2"x16 180x16x66	<b>16,620</b>	1
07658.002	1/2"x20 180x20x68	<b>20,120</b>	1

**art. 7659**

Raccordo curvo doppio flangiato femmina a pressare per tubo multistrato multipinza profilo TH-H.



07659.001	1/2"x16	<b>16,450</b>	5
07659.002	1/2"x20	<b>16,800</b>	5

### art. 7660

Raccordo curvo sede piana con dado girevole a pressare per tubo multistrato multipinza profilo TH-H.

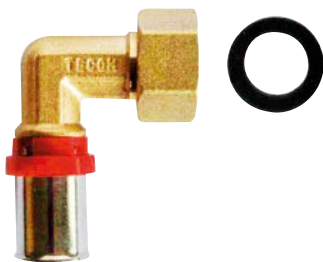

cod. art.	mis.	€	conf.
07660.001	1/2"x16	6,650	10
07660.002	1/2"x20	7,350	10
07660.003	3/4"x20	8,750	10

### art. 7661

Raccordo curvo femmina a pressare per tubo multistrato multipinza profilo TH-H.



07661.001	1/2"x16	7,410	10
07661.002	1/2"x20	10,010	10
07661.003	3/4"x20	11,610	10
07661.004	3/4"x26	14,520	5
07661.005	1"x26	17,320	5
07661.006	1"x32	21,870	5

### art. 7662

Raccordo a Tee maschio femmina a pressare per tubo multistrato multipinza profilo TH-H.



07662.001	1/2"x16	7,410	10
07662.002	1/2"x20	10,010	10
07662.003	3/4"x20	11,610	10
07662.004	3/4"x26	14,520	5
07662.005	1"x26	17,320	5
07662.006	1"x32	21,870	5

### art. 7663

Raccordo a Tee a pressare per tubo multistrato multipinza profilo TH-H.



07663.001	16x16x16	7,100	10
07663.002	20x20x20	10,010	10
07663.003	26x26x26	18,370	5
07663.004	32x32x32	24,500	5

### art. 7663R

Raccordo a Tee ridotto a pressare per tubo multistrato multipinza profilo TH-H.



7663R.001	20x16x16	12,070	5
7663R.002	20x16x20	13,410	5
7663R.003	26x16x26	19,360	5
7663R.004	26x20x20	17,150	5
7663R.005	26x20x26	19,600	5
7663R.006	32x20x32	29,010	5
7663R.007	32x26x26	25,750	5
7663R.008	32x26x32	29,210	5

### art. 7664

Rubinetto incasso a vitone completo di cappuccio e rosone scorrevole a pressare per tubo multistrato multipinza profilo TH-H.

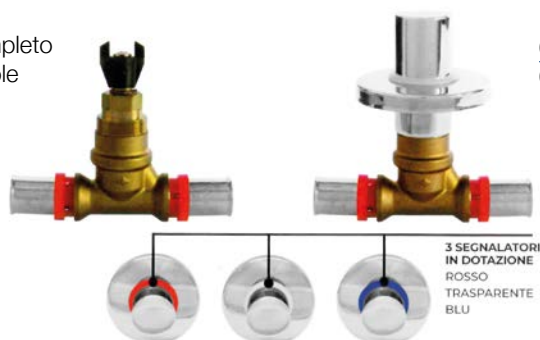

07664.001	16x16	28,860	1
07664.002	20x20	30,610	1

### art. 7665

Prolunga per rubinetto a incasso.



07665.000		4,780	10
-----------	--	-------	----

**art. 7667**

Adattatore sede piana a pressare per tubo multistrato multipinza profilo TH-H.



cod. art.	mis.	€	conf.
07667.001	16x16	<b>4,280</b>	10
07667.002	20x20	<b>5,250</b>	10

**art. 7668**

Adattatore sede piana a pressare per tubo multistrato multipinza profilo TH-H.



07668.001	1/2"x16	<b>4,620</b>	10
07668.001	1/2"x20	<b>5,740</b>	10

**art. 7670**

Collettore in ottone stampato con chiusure inclinate. 3/4"x1/2"x16



07670.002	2 vie	<b>17,560</b>	1
07670.003	3 vie	<b>26,270</b>	1
07670.004	4 vie	<b>35,020</b>	1
07670.005	5 vie	<b>43,760</b>	1

**art. 7671C**

Coppia adattatori per tubo multistrato. 1/2"x16x2,0 mm



<b>7671C.COP</b>	1/2"x16	<b>5,300 (2pz)</b>	50
------------------	---------	--------------------	----

**art. 7672**

Valvola a squadra per collettore con bocchettone orientabile a 360°.

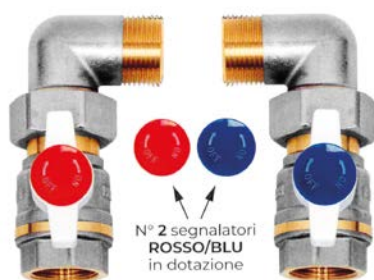

07672.001	1/2"	<b>17,500</b>	1
07672.002	3/4"	<b>23,540</b>	1
07672.003	1"	<b>36,100</b>	1

## art. 7676

Kit collettori premontati  
in acciaio inossidabile AISI 304  
per impianto radiante con regolazione  
indipendente dei singoli circuiti.

### Completo di:

- Misuratori di portata
- Valvole termostattizzabili
- Valvole a sfera
- Termometri
- Valvole automatiche sfogo aria
- Valvole carico/scarico impianto
- Staffe di fissaggio

## KIT COLLETTORE A 6 VIE

### Caratteristiche tecniche:

- Temperatura di esercizio min.: 5°C
- Temperatura di esercizio max.: 70°C
- Pressione di esercizio max.: 6 bar
- Portata flussimetri: 0÷5 L/min
- Interasse vie: 50 mm
- Diametro ingresso: F 1"
- Diametro uscite: M 3/4" Eurocono
- Collegamento teste elettrotermiche: M30x15
- Materiale collettore: Acciaio AISI 304
- Materiale valvole: Ottone CW617N
- Manopola di chiusura: ABS
- Staffe di fissaggio: Acciaio
- Fluidio d'impiego: Acqua/Glicole
- Max. percentuale Glicole: 30%

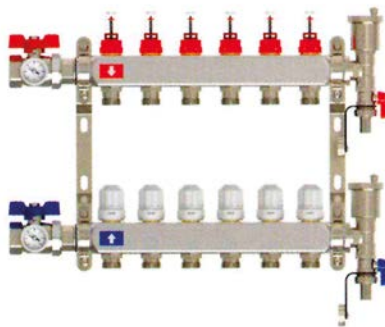

cod. art.	mis.	€	conf.
07676.006	1"x3/4"	337,000	1

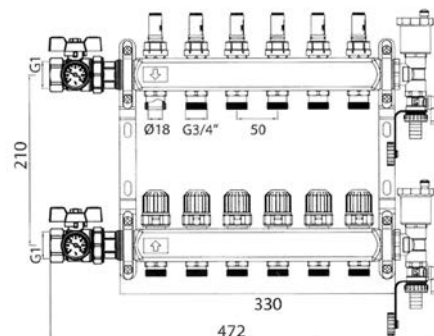

## KIT COLLETTORE A 7 VIE

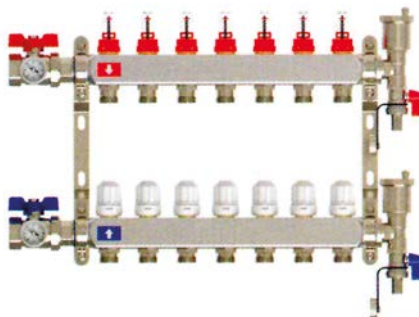

07676.007	1"x3/4"	365,000	1
-----------	---------	---------	---

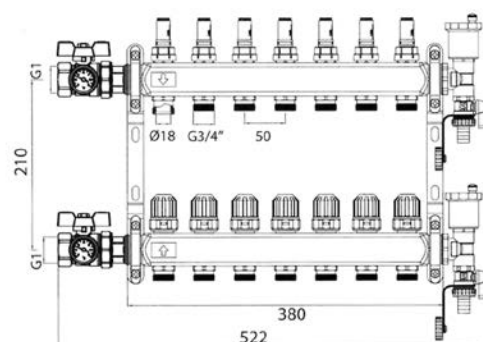

## KIT COLLETTORE A 8 VIE

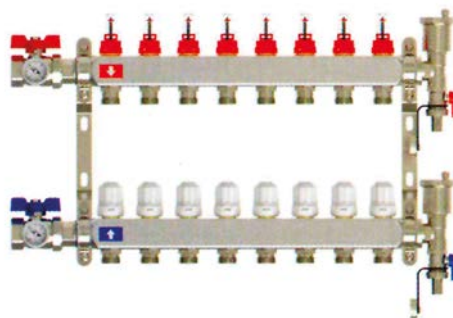

07676.008	1"x3/4"	397,000	1
-----------	---------	---------	---

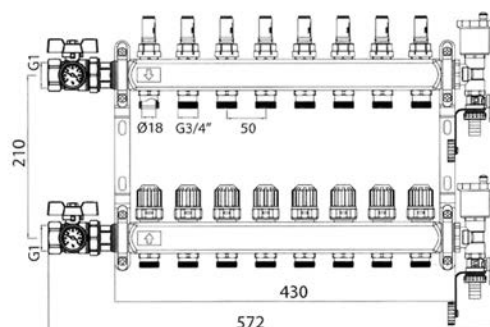

## KIT COLLETTORE A 9 VIE

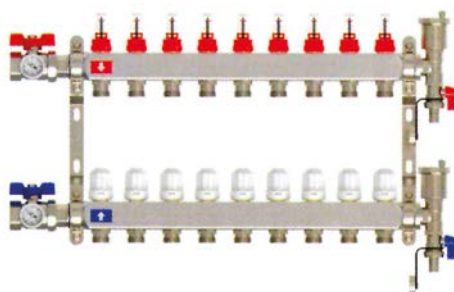

07676.009	1"x3/4"	425,000	1
-----------	---------	---------	---

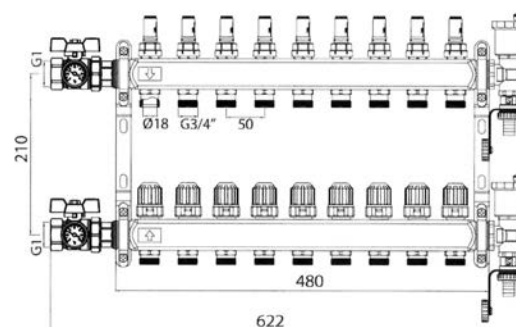

## KIT COLLETTORE A 10 VIE

cod. art.	mis.	€	conf.
07676.010	1"x3/4"	457,000	1

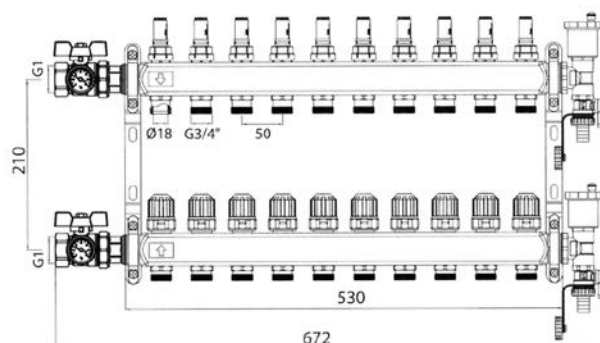
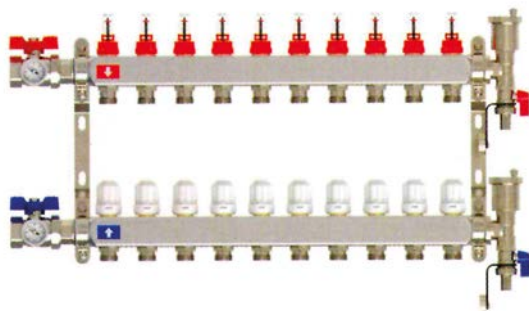

## KIT COLLETTORE A 11 VIE

cod. art.	mis.	€	conf.
07676.011	1"x3/4"	489,000	1

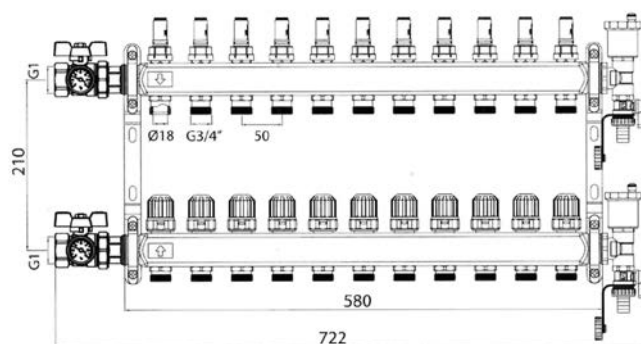
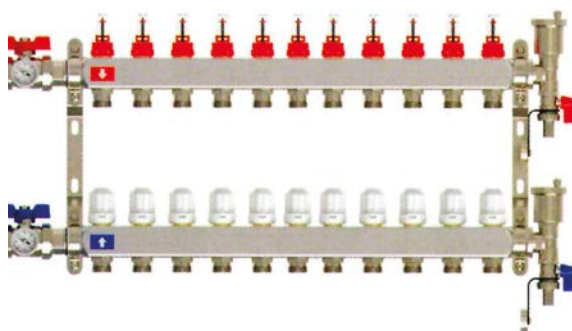

## KIT COLLETTORE A 12 VIE

cod. art.	mis.	€	conf.
07676.012	1"x3/4"	524,000	1

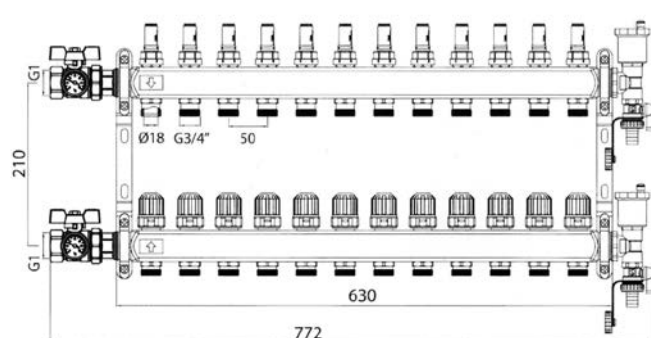
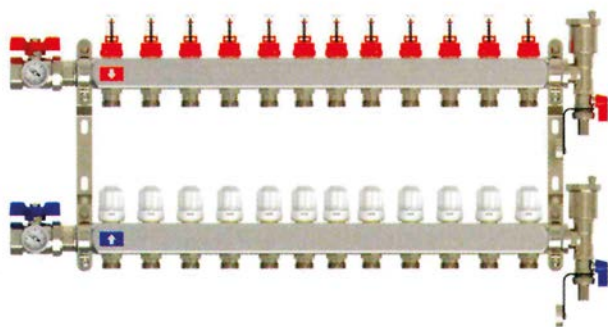

### art. 7675

Adattatore per tubo polietilene  
3/4"x17.



cod. art.	mis.	€	conf.
07675.000	3/4"x17	5,300	10

## art. 7680

Pressatrice professionale a batteria 18V con ritorno automatico del pistone a pressatura effettuata.

**N.B. Ganasce non incluse nella confezione**

### Dati tecnici

- Forza di pressatura: 32 KN
- Corsa pistone: 40 mm
- Campo di pressatura:  
Tubo in acciaio inossidabile a basso spessore da Ø12 a 54 mm  
Tubo multistrat e tubo in rame da Ø12 a 108 mm
- Tempo di pressatura: circa 6 sec. (in base al Ø del tubo)
- Capacità olio: 115ml
- Olio idraulico: Shell Tellus T15 o similari
- Temp. di esercizio: da -10 a +40°C
- Voltaggio della batteria: CC 18 V, 4,0 AH
- Tensione di carica: CA 100 V ~ 240 V; 50 - 60 HZ
- Tempo di ricarica: circa 80 min.
- Peso: 3,9Kg (con batteria)
- Dim. pressatrice: 338x322x84 mm

### Accessori in dotazione

- Batteria: 2 pezzi
- Carica batterie: 1 pezzo
- Cinghia a tracolla: 1 pezzo
- Valigia: 1 pezzo



## art. 7682

Ganascia standard profilo TH.

Ricambio per pressatrice art. 7680



07682.016	Ø16 mm	187,000	1
07682.020	Ø20 mm	187,000	1
07682.026	Ø26 mm	187,000	1
07682.032	Ø32 mm	187,000	1
07682.040	Ø40 mm	220,000	1

**art. 7673**

Chiave per dado collettore.  
24x27mm



cod. art.	mis.	€	conf.
07673.000		18,500	10

**art. 7674**

Dima per impianti con livella  
con possibilità di mettere in dima  
gli impianti con interassi:  
20-100-150-200 mm



07674.000		8,400	1
-----------	--	-------	---

**art. 1979**

Calibratore svasatore con lame  
per tubo multistrato.  
Ø 16 - 20 - 26 mm

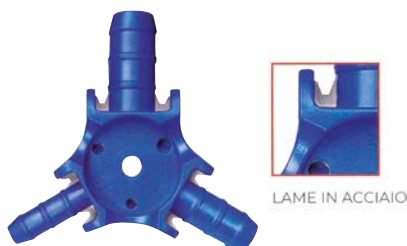

01979.000		16,000	1
-----------	--	--------	---

**art. 1973**

Espansore per tubi in rame.



01973.000		74,000	1
-----------	--	--------	---

**art. 1977L**

Cesoia professionale per tubi di plastica.  
Avanzamento della lama a cricco,  
apertura rapida dopo il taglio.  
Gancio di chiusura, taglio senza  
sbavature  
dei tubi di plastica in PE, PE-X,  
PP, VPE, PB, PVDF.



1977L.PRO		35,000	1
-----------	--	--------	---

### art. **32VIT**

Vitone passo rapido  
asta mobile.



cod. art.	mis.	€	conf.
<b>32VIT.027</b>	Ø 27	<b>48,500</b>	2
<b>32VIT.028</b>	Ø 28	<b>48,500</b>	2
<b>32VIT.029</b>	Ø 29	<b>48,500</b>	2

### art. **32SED**

Sede per passo rapido incasso.



<b>32SED.001</b>	Ø 21x19	<b>13,000</b>	2
<b>32SED.002</b>	Ø 21x1	<b>12,000</b>	2
<b>32SED.003</b>	Ø 23x1	<b>12,000</b>	2
<b>32SED.004</b>	Ø 24x1	<b>13,000</b>	2

### art. **32KIT**

Kit trasformazione da passo rapido  
a cassetta esterna.



<b>32KIT.000</b>		<b>64,000</b>	1
------------------	--	---------------	---

### art. **311CH**

Farfalla blu con serratura di sicurezza.  
(Compatibile solo con articolo 311PE).



<b>311CH.SE1</b>	1/2" e 3/4"	<b>50,500</b>	1
<b>311CH.SE2</b>	1"	<b>50,500</b>	1

### art. 10579

Aeratore con doppio snodo in ottone cromato completo di adattatore M.24x1 x M.22x1.

Lavabo, Bidet, Cucina.



cod. art.	mis.	€	conf.
10579.000		12,600	5

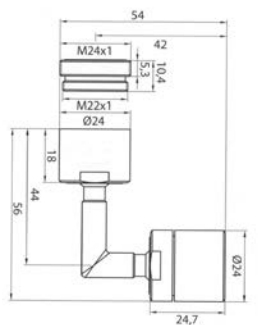

### art. 2163

Aeratore filetto maschio ø 20x1 per lavabo.

Finitura: Cromo 00



02163.000		6,040	10
-----------	--	-------	----

### art. 1073

Sedile WC bianco avvolgente in termoindurente con cerniere in acciaio.

Soft-close sganciabile



01073.AVV	1,80 Kg	64,000	1
-----------	---------	--------	---

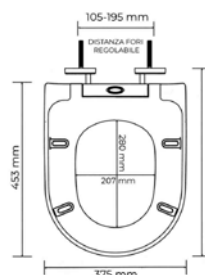

### art. 1073R

Coppia cerniere in acciaio per ricambio sedile (Art. 1073).



1073R.RIC		10,000	1
-----------	--	--------	---

### art. 1065A

Sedile WC Universale in MDF con cerniere in acciaio inox.

#### Caratteristiche tecniche:

- Materiale sedile: MDF
- Materiale cerniere: acciaio inox
- Materiale fissaggi: acciaio inox
- Materiale chiave: nylon
- Colore: bianco
- Peso: 2,5 Kg



CERNIERE REGOLABILI IN ACCIAIO INOX



FISSAGGI IN ACCIAIO INOX

1065A.000		42,000	1
-----------	--	--------	---

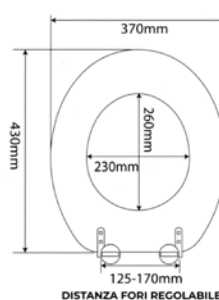

## FISSAGGIO ADESIVO

Sistema di fissaggio  
con adesivo 3M.  
**Pratico, semplice  
e sicuro!**



### art. 7870

Appendino singolo  
con sistema di fissaggio  
adesivo 3M.  
Acciaio cromato.

Serie Giada



cod. art.	mis.	€	conf.
07870.000		10,500	2

### art. 7871

Appendino doppio  
con sistema di fissaggio  
adesivo 3M.  
Acciaio cromato.

Serie Giada



07871.000		20,400	2
-----------	--	--------	---

### art. 7872

Porta salviette 45 cm  
con sistema di fissaggio  
adesivo 3M.  
Acciaio cromato.

Serie Giada



07872.000	L 450 mm	27,900	2
-----------	----------	--------	---

### art. 7873

Porta ad anello  
con sistema di fissaggio  
adesivo 3M.  
Acciaio cromato.

Serie Giada



07873.000		22,100	2
-----------	--	--------	---

**art. 7874**

Portarotolo  
con sistema di fissaggio  
adesivo 3M.  
Acciaio cromato.

Serie Giada



cod. art.	mis.	€	conf.
07874.000		20,400	2

**art. 7875**

Portascopino  
con sistema di fissaggio  
adesivo 3M.  
Acciaio cromato.

Serie Giada

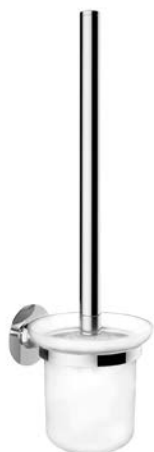

07875.000		33,700	2
-----------	--	--------	---

**art. 7876**

Portaoggetti  
con sistema di fissaggio  
adesivo 3M.  
Acciaio cromato.

Serie Giada

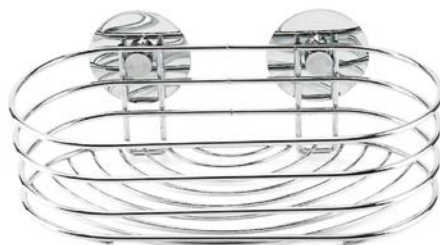

07876.000	L235xH98xP125 mm	34,800	2
-----------	------------------	--------	---

**art. 7877**

Angoiera per doccia  
con sistema di fissaggio  
adesivo 3M.  
Acciaio cromato.

Serie Giada

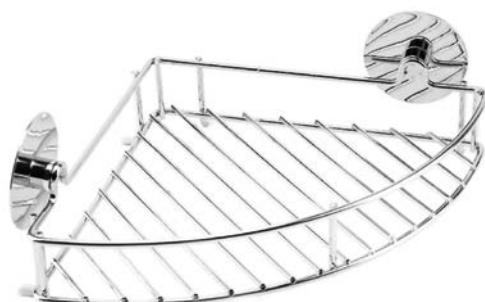

07877.000	L285xH90xP220 mm	34,800	2
-----------	------------------	--------	---

art. **7878**

Appendino Universale in ABS  
per scaldasalviette.

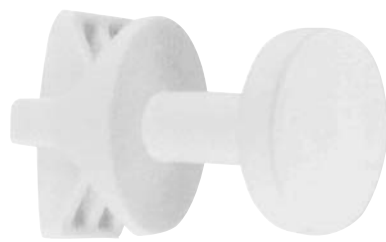

cod. art.	mis.	€	conf.
07878.BIA	bianco	<b>7,600</b>	1
07878.CRO	cromato	<b>11,500</b>	1

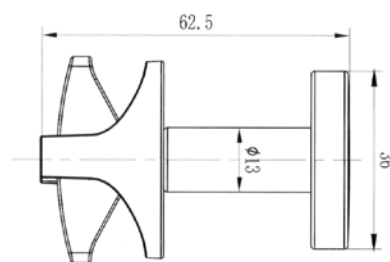
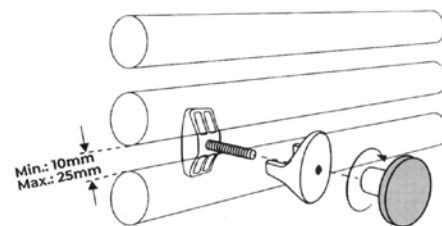

art. **7879**

Appendino Universale  
magnetico in acciaio.  
Peso max. supportabile: 2 Kg



07879.CRO	cromato	<b>25,000</b>	1
07879.BIA	bianco	<b>27,000</b>	1

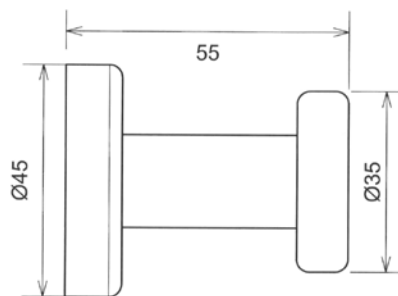

# Bordoflex

## PROFILO PER DOCCIA E VASCA

Lunghezza profilo 4 metri

 **MADE IN ITALY**

**FACILE DA INSTALLARE**  
**REALIZZATO IN ACRILICO E NON IN PVC**  
**RESISTENTE AI RAGGI UV**  
**NON INGIALLISCE**



### art. 7725

Prodotto ideale per sigillare la fuga tra il muro e la vasca da bagno o il piatto doccia.  
Il prodotto è realizzato in acrilico e non in PVC.  
Grazie al Kit di angolari e terminali l'installazione risulta facile e veloce.

cod. art.	mis.	€	conf.
07725.000	4 m	69,000	1

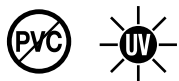

### UTILIZZO SILICONE

Il prodotto va incollato mediante l'uso di silicone in quanto il biadesivo presente sulla guarnizione ha la sola funzione di posizionamento.

Si consiglia l'uso di un silicone su base poliuretanic.

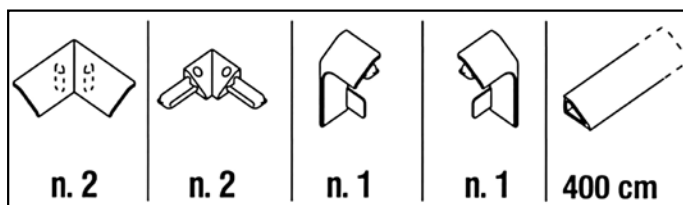

### art. 7388

Elettropompa Jet autoadescante con girante in ottone 0,75 HP.

cod. art.	mis.	€	conf.
07388.750	0,75HP	237,000	1

#### Caratteristiche tecniche

- Prevalenza massima: 44 m
- Prevalenza minima: 20 m
- Portata massima: 47 l/min
- Altezza di aspirazione manometrica: 9 m con valvola di fondo
- P1 potenza nominale assorbita: 750 W
- P2 potenza nominale resa albeo: 550 W - 0,75 HP
- Tensione nominale di alimentazione: 220-230 V
- Frequenza nominale: 50 Hz
- Capacità del condensatore: 16 µF
- Numero giri minuto: 2850
- Grado di protezione: IPX4
- Classe di isolamento: F
- Temp. massima ambiente: 40°C
- Tipo di liquido: Acqua pulita
- Temp. minima del liquido: 5°C
- Temp. massima del liquido: 40°C
- Utilizzo: Domestico
- Tipologia: Pompa di superficie
- Bocca di aspirazione: F da 1"
- Bocca di mandata: F da 1"
- Peso netto: 13,4 Kg
- Peso lordo: 14 Kg

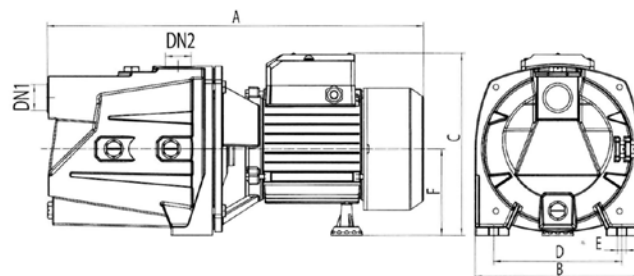
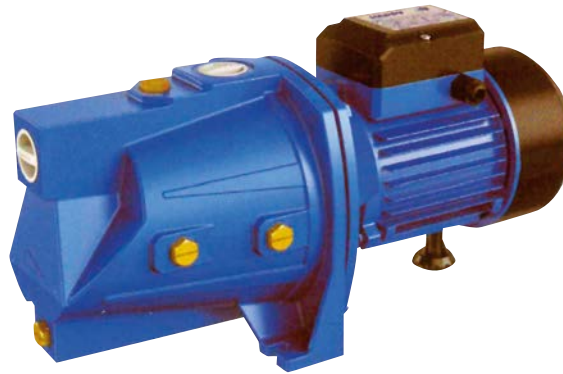

DIMENSIONI							
DN1	DN2	A	B	C	D	E	F
1"	1"	438	192	210	148	10	99

### art. 7388A

Elettropompa Jet autoadescante con girante in ottone 1 HP.

7388A.100	1HP	248,000	1
-----------	-----	---------	---

#### Caratteristiche tecniche

- Prevalenza massima: 49 m
- Prevalenza minima: 20 m
- Portata massima: 50 l/min
- Altezza di aspirazione manometrica: 9 m con valvola di fondo
- P1 potenza nominale assorbita: 1000 W
- P2 potenza nominale resa albeo: 750 W - 1 HP
- Tensione nominale di alimentazione: 220-230 V
- Frequenza nominale: 50 Hz
- Capacità del condensatore: 20 µF
- Numero giri minuto: 2850
- Grado di protezione: IPX4
- Classe di isolamento: F
- Temp. massima ambiente: 40°C
- Tipo di liquido: Acqua pulita
- Temp. minima del liquido: 5°C
- Temp. massima del liquido: 40°C
- Utilizzo: Domestico
- Tipologia: Pompa di superficie
- Bocca di aspirazione: F da 1"
- Bocca di mandata: F da 1"
- Peso netto: 14,4 Kg
- Peso lordo: 16 Kg

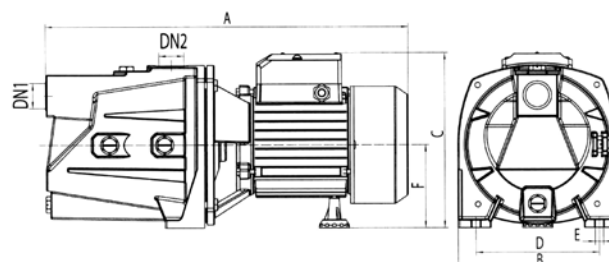
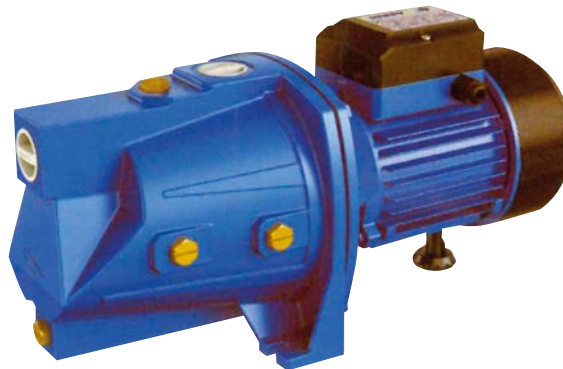

DIMENSIONI							
DN1	DN2	A	B	C	D	E	F
1"	1"	438	192	210	148	10	99

**art. 7388B**

Elettropompa Jet autoadescante con girante in ottone 1,5 HP.

cod. art.	mis.	€	conf.
<b>7388B.150</b>	1,5HP	<b>448,000</b>	1

**Caratteristiche tecniche**

- Prevalenza massima: 56 m
- Prevalenza minima: 20 m
- Portata massima: 90 l/min
- Altezza di aspirazione manometrica: 9 m con valvola di fondo
- P1 potenza nominale assorbita: 1600 W
- P2 potenza nominale resa albeo: 1100 W - 1,5 HP
- Tensione nominale di alimentazione: 220-230 V
- Frequenza nominale: 50 Hz
- Capacità del condensatore: 40 µF
- Numero giri minuto: 2850
- Grado di protezione: IPX4
- Classe di isolamento: F
- Temp. massima ambiente: 40°C
- Tipo di liquido: Acqua pulita
- Temp. minima del liquido: 5°C
- Temp. massima del liquido: 40°C
- Utilizzo: Domestico
- Tipologia: Pompa di superficie
- Bocca di aspirazione: F da 1"1/4
- Bocca di mandata: F da 1"
- Peso netto: 28,8 Kg
- Peso lordo: 23,6 Kg

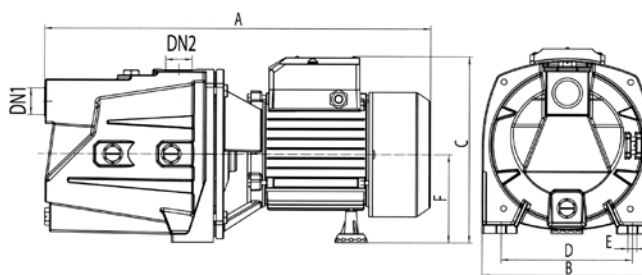
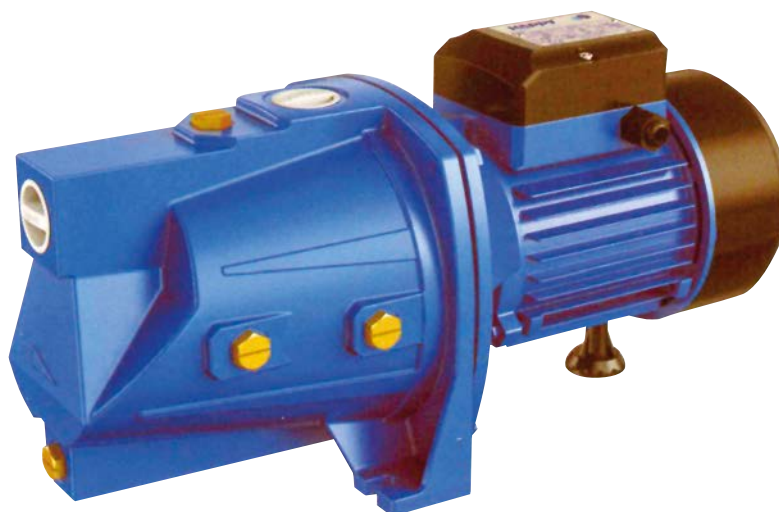

DIMENSIONI							
DN1	DN2	A	B	C	D	E	F
1"1/4	1"	515	210	237	166	11	144



art. **7745**

**TEC7 CLEANER**

Solvente universale a rapida evaporazione. Pulisce e sgrassa velocemente, è pronto all'uso, non danneggia le superfici e non lascia residui oleosi. Ideale per la rifinitura di cordoni di sillanti e giunture. Rimuove siliconi e polimeri, adesivi ed etichette. Chiude le porosità della sigillatura impedendo alla muffa/polvere di penetrare, aumentando la durata contro l'ingiallimento e favorisce la guarnizione/sigillatura.



cod. art.	mis.	€	conf.
07745.000	500 ml	<b>22,900</b>	12



art. **7744**

**HP CLEAN**

Pulitore a base acqua, pulisce e sgrassa tutte le superfici. Senza solventi e senza acidi, ideale prima di incollaggi, sigillature, saldature, rivestimenti. Sicuro sulla pelle, completamente biodegradabile. Utilizzabile con idropulitrici e lavapavimenti, diluito a 1/10. Adatto a tutte le superfici, veicoli (all'interno e all'esterno), tessuti estremamente sporchi. Conforme alla normativa HACCP.



07744.000	1 lt.	<b>24,900</b>	12
-----------	-------	---------------	----

**art. 7746**
**TRANS CLEAR**

Sigillante invisibile cristallino per tutti i materiali, anche in immersione.

Buone proprietà di incollaggio, aderisce su substrati sia asciutti che bagnati. Ideale per la sigillatura di tutti i materiali da costruzione, dove è richiesta la perfetta trasparenza. ideale per la sigillatura su pietra naturale e superfici, porose e non porose, dove il rischio di fare macchie si deve assolutamente evitare. Resistente ai batteri e fungicida. Dopo la polimerizzazione rimane permanentemente elastico. Senza solventi o isocianati. Sicuro su specchi, non lascia residui sulla pietra naturale. Quasi privo di odore. Ideale anche per superfici bagnate e scivolose. Resistente all'acqua e all'aria. Per la sigillatura e incollaggio di mattonelle, pietra naturale, legno, cemento, alluminio. Eccellente per bagni, pavimenti in legno, tettoie.

Per la sigillatura di infissi (porte e finestre, uso interno). Sovra verniciabile con la maggior parte delle pitture comuni. TRANS CLEAR ha minore adesione su PP, PE, Bitume e siliconi. Certificato per uso nel settore alimentare. NB: Per applicazioni in cui si ha necessità di tenute elevatissime, si consiglia l'uso di TEC7.



cod. art.	mis.	€	conf.
07746.000	310 ml Cristallino	<b>31,800</b>	12

**art. 7747**
**TEC7**

Sigillare e incollare con un solo prodotto, anche sott'acqua.

Capacità di incollaggio eccezionale, elevata resistenza ai raggi UV e ai funghi. Polimerizza rapidamente senza ritiro elastico. Rimane flessibile e resistente alle vibrazioni. Incolla sia su superfici asciutte che bagnate. Utilizzabile sia all'interno che all'esterno. Sicuro su specchi, non lascia residui sulla pietra naturale. Quasi privo di odore. Può edere utilizzato sulla maggior parte dei materiali da costruzione. TEC7 sostituisce colle di montaggio, colle per legno e adesivi poliuretanici, sigillanti siliconici, siliconi sanitari, adesivi acrilici, sigillanti a base di gomma butilica. Ideale su pietra naturale (senza macchiare), metallo (prevenendo la formazione di ruggine), poliestere, schiuma di polistirene. Sovra verniciabile con la maggior parte delle pitture comuni. TEC7 ha minore adesione su PP, PE, bitume e siliconi. Grazie alla certificazione alimentare può essere usato nel settore sanitario. Dispone di certificazione nautica. Senza ftalati, solventi e isocianati.



07747.000	310 ml Bianco	<b>29,100</b>	12
-----------	---------------	---------------	----

### art. 8721

Chiave universale professionale  
combinazioni per sportello  
acqua - gas - luce.



### art. 8717

Cutter in ABS con manico  
ergonomico antiscivolo  
con 3 lame in dotazione  
in acciaio a settori  
18x100 mm



### art. 8717R

10 lame in acciaio  
per cutter 18x100 mm  
Lame in acciaio a settori.

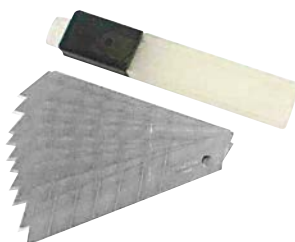

### art. 8718

Kit cartellatrice universale  
per tubi in pollici da 3/16" a 5/8"  
per tubi in mm da 5 a 16.

Completa di:

- Tagliatubi da 3 a 22 mm
- Sbatatubi girevoli con lama  
di ricambio.



### art. 8719

Kit cartellatrice a frizione  
per tubi in pollici da 3/16" a 5/8".

Completa di:

- Tagliatubi da 3 a 22 mm
- Sbatatubi girevoli con lama  
di ricambio.



cod. art.	mis.	€	conf.
08721.000		29,000	1

08717.000		5,700	1
-----------	--	-------	---

8717R.RIC		3,800	10
-----------	--	-------	----

08718.000		81,000	1
-----------	--	--------	---

08719.000		104,000	1
-----------	--	---------	---

**art. 152EC**

Pistola stura scarichi ad aria compressa, uso semplicissimo. Ideale per lavabo, bidet, vasche da bagno, doccia, WC, lavelli, etc. Completa di 4 adattatori in gomma.



cod. art.	mis.	€	conf.
<b>152EC.000</b>		<b>48,000</b>	1

**art. 8704**

Chiave per codoli radiatore da 3/8" a 1" con manico rosso o blu.



<b>08704.ROS</b>		<b>53,000</b>	1
<b>08704.BLU</b>		<b>53,000</b>	1

**art. 8704R**

Chiave a scalino per codoli radiatore da 3/8" a 1".



<b>8704R.RIC</b>		<b>21,400</b>	1
------------------	--	---------------	---

**art. 8703**

Set 7 pezzi chiavi combinate a cricchetto Chrome Vanadium nelle seguenti misure: 8-10-12-13-14-17-19 mm



<b>08703.SET</b>		<b>92,000</b>	1
------------------	--	---------------	---

**art. 8702**

Set 13 pezzi cricchetto Il set comprende:  
 - Cricchetto da 1/4" con manico ergonomico  
 - 1 prolunga maschio femmina da 1/4"  
 - 13 pezzi bussole da:  
 44, 5, 6, 7, 8, 9, 10, 11, 12, 13, 14 mm



<b>08702.SET</b>		<b>37,900</b>	1
------------------	--	---------------	---

**art. 8720**

Set 5 pinze assortite  
in acciaio.



cod. art.	mis.	€	conf.
08720.KIT		55,000	1

**art. 8701**

Set 2 pezzi chiavi universali  
per tutti i tipi di dadi e  
raccordi da 9 a 32 mm



08701.SET		20,900	1
-----------	--	--------	---

**art. 8700**

Chiave a rullino.



08700.200	200 mm	12,550	1
08700.250	250 mm	18,100	1

**art. 8725**

Pinza universale i acciaio.



08725.000	180 mm	11,200	1
-----------	--------	--------	---

**art. 8726**

Pinza becchi semitondi piegati.  
Chrome vanadium.



08726.000	160 mm	12,800	1
-----------	--------	--------	---

**art. 8727**

Pinza becchi semitondi.  
Chrome vanadium.



cod. art.	mis.	€	conf.
08727.000	160 mm	11,200	1

**art. 8728**

Tronchese taglio diagonale.  
Chrome vanadium.



08728.000	160 mm	12,100	1
-----------	--------	--------	---

**art. 8729**

Set cacciaviti 4 pezzi  
Chrome Vanadium.  
Cacciavite con puntali magnetici  
per un miglior controllo e fissaggio  
della vite.  
L'acciaio viene trattato termicamente  
per una maggiore resistenza e durata.



08729.004		14,400	1
-----------	--	--------	---

CONTIENE I SEGUENTI CACCIAVITI:

- ⊖ 5x75 mm    ⊕ PH1x75 mm
- ⊖ 6x100 mm    ⊕ PH2x100 mm

**art. 8729M**

Set cacciaviti 10 pezzi  
Chrome Vanadium.  
Cacciavite con puntali magnetici  
per un miglior controllo e fissaggio  
della vite.  
L'acciaio viene trattato termicamente  
per una maggiore resistenza e durata.



8729M.010		26,000	1
-----------	--	--------	---

CONTIENE I SEGUENTI CACCIAVITI:

- ⊖ 3x75 mm    ⊕ PH0x75 mm    ⊕ PZ1x75 mm
- ⊖ 4x100 mm    ⊕ PH1x75 mm    ⊕ PZ2x100 mm
- ⊖ 5x125 mm    ⊕ PH2x100 mm
- ⊖ 6x150 mm
- ⊖ 8x150 mm

art. **8705**

Set estrattori conici in acciaio  
5 pezzi per viti e prigionieri.



cod. art.	mis.	€	conf.
08705.000		9,300	1

art. **8711**

Localizzatore di foratura  
in alluminio.  
Righello pieghevole  
con 6 articolazioni.

08711.000		32,000	1
-----------	--	--------	---

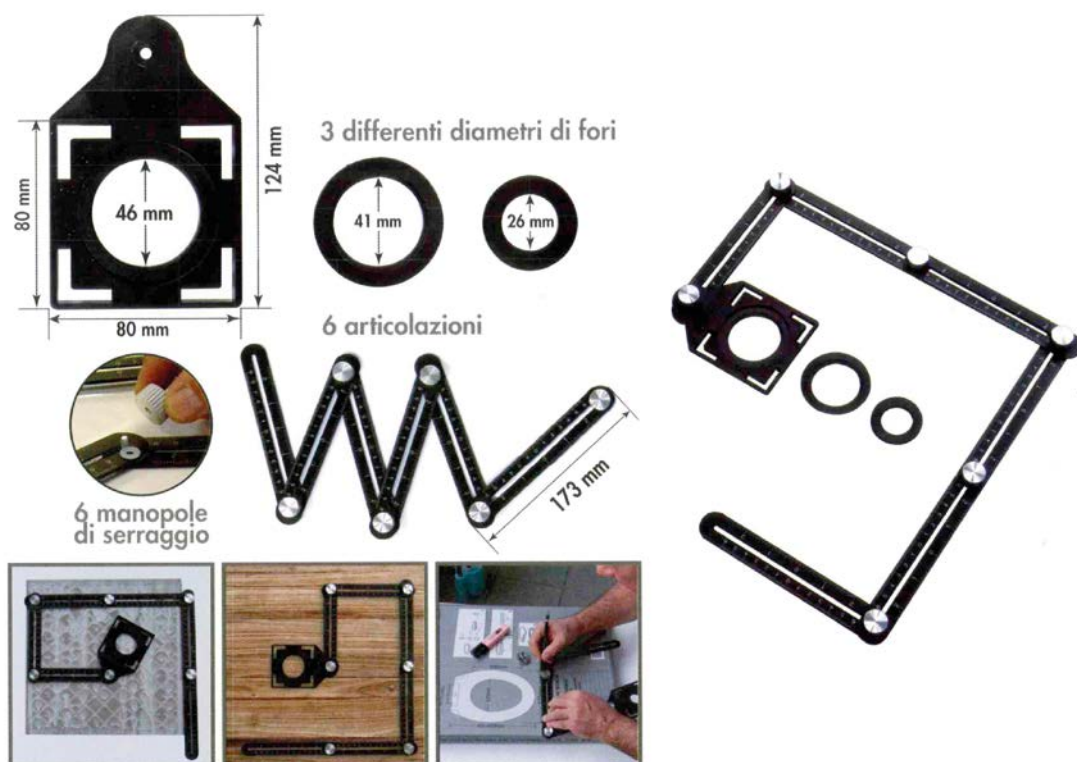



**FUGAZZOLA s.r.l.**

24040 Misano Gera d'Adda (Bg)  
via E. Carioni, 40  
tel. +39 0363.84054 r.a.  
fax +39 0363.84777  
e-mail: [info@fugazzola.it](mailto:info@fugazzola.it)  
sito: [www.fugazzola.it](http://www.fugazzola.it)

PRESENTI SU 